

## HyperX Alloy FPS Keyboard

Find the language and latest documentation for your HyperX Alloy FPS Keyboard here.

### HyperX Alloy FPS Keyboard Installation Guide

-  ..... For instructions in English
-  ..... Para instrucciones en Español
-  ..... Für Anleitungen in Deutsch
-  ..... Pour des instructions en Français
-  ..... Per le istruzioni in Italiano
-  ..... Por as instruções em Português
-  ..... Instrukcje w języku Polskim
-  ..... Для инструкции на Русском
-  ..... Turkce talimatlar icin
-  ..... Japanese
-  ..... Korean
-  ..... Thai
-  ..... Vietnamese
- Simplified Chinese ..... 中文说明
- Traditional Chinese ..... 中文說明



# HyperX Alloy FPS Mechanical Gaming Keyboard



Part Numbers		
Cherry® MX Blue	Cherry® MX Brown	Cherry® MX Red
HX-KB1BL1-NA/A3	HX-KB1BR1-RU/A5	HX-KB1RD1-RU/A5
HX-KB1BL1-LA/A4	HX-KB1BR1-DE/A2	HX-KB1RD1-DE/A2
HX-KB1BL1-RU/A5	HX-KB1BR1-LA/A4	HX-KB1RD1-LA/A4
HX-KB1BL1-NA/A1	HX-KB1BR1-NA/A1	HX-KB1RD1-NA/A1
HX-KB1BL1-DE/A2	HX-KB1BR1-NA/A2	HX-KB1RD1-NA/A2
HX-KB1BL1-NO/A2	HX-KB1BR1-NA/A3	HX-KB1RD1-NA/A3
HX-KB1BL1-UK/A2	HX-KB1BR1-NA/A4	HX-KB1RD1-NA/A4
HX-KB1BL1-NA/A4	HX-KB1BR1-NO/A2	HX-KB1RD1-NO/A2
HX-KB1BL1-NA/A2	HX-KB1BR1-UK/A2	HX-KB1RD1-UK/A2
HX-KB1BL1-FR/A2	HX-KB1BR1-FR/A2	HX-KB1RD1-FR/A2



### What's included:

- HyperX Alloy FPS Mechanical Gaming Keyboard
- Detachable USB cable
- 8x Gaming keycaps
- Keycaps puller
- Travel pouch





## Keyboard Overview:

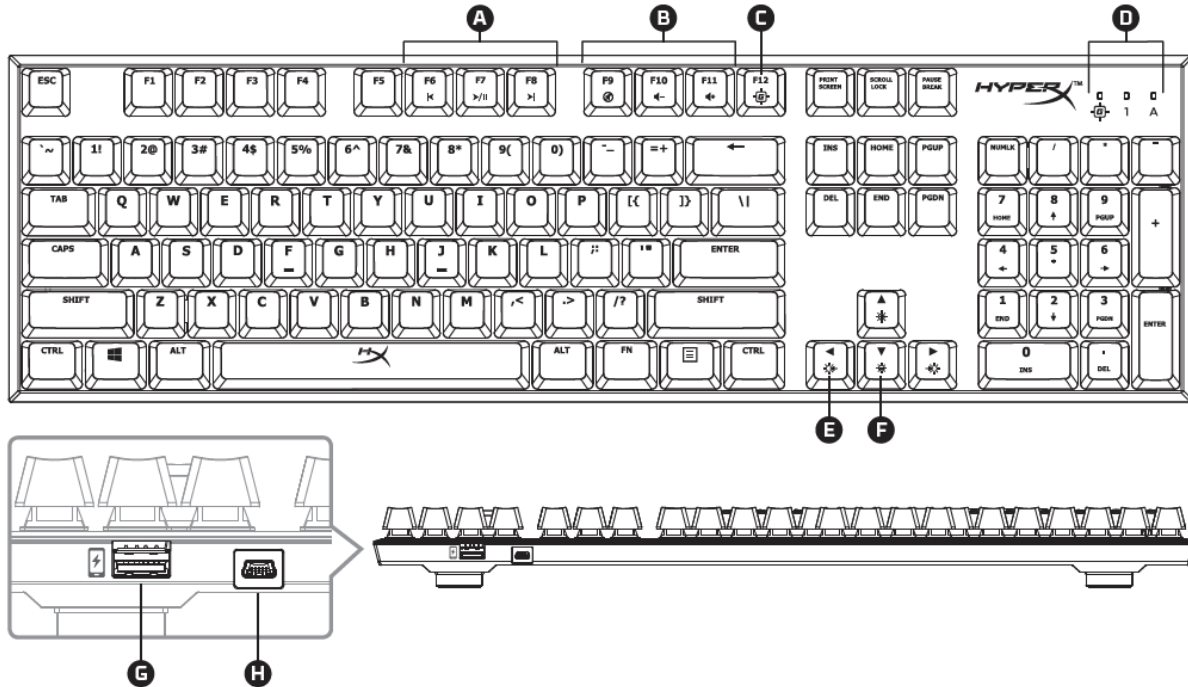

A- F6 F7 F8 = Media keys.

B- F9 F10 F11 = Volume control keys.

C- F12 = Game Mode key.

D- Game Mode / Num Lock / Caps Lock indicators.

E- Left & Right = LED mode control keys.

F- Up & Down = LED brightness control keys.

G- Back USB port = Mobile phone USB charging port.

H- Back mini USB port = Keyboard USB cable port.



**Keyboard Installation:**

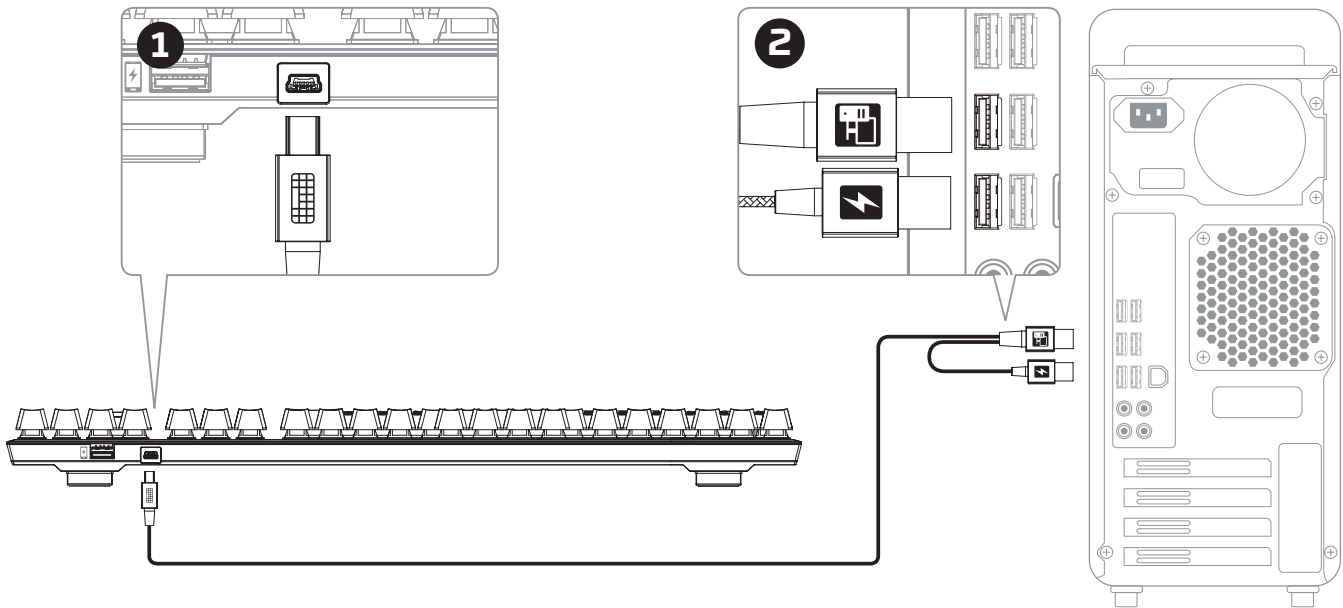

- 1- Connect the Mini USB connector to the keyboard.
- 2- Connect both USB connectors to the computer.



**Function Keys:**



Press “FN” and a function key at the same time to activate its secondary feature.

Function Keys	Secondary Feature
<p style="text-align: center;">FN + F6 F7 F8 ⏪ &gt;/   ⏩</p>	<p>Play/pause &gt;/  , skip backwards ⏪ or skip forward ⏩ your music or video.</p>
<p style="text-align: center;">FN + F9 F10 F11 🔇 🔊- 🔊+</p>	<p>Mute 🔇, decrease 🔊- or increase 🔊+ your computer audio.</p>
<p style="text-align: center;">FN + F12 🎮</p>	<p>Enable Game Mode 🎮 to disable the Windows key and avoid accidental interruption during gaming. When Game Mode is enabled the indicator will illuminate.</p>
<p style="text-align: center;">FN + ⬆️ ⬇️ ⬆️</p>	<p>Increase 🌞+ or decrease 🌞- the LED backlight brightness. There are 5 levels of brightness: OFF, 25%, 50%, 75% and 100%.</p>



	<p>Switch between the LED backlight modes with the following keys  / .</p>
--	--

**LED backlight modes:**

There are six LED backlight modes: Solid ► Breathing ► Trigger ► Explosion ► Wave ► Custom.

- Solid: Constant lightning (default setting).
- Breathing: Slow blinking that mimics breathing.
- Trigger: Individuals keys will light up when pressed and slowly fade after one second.
- Explosion: A lighting effect will radiate from individual keys when pressed.
- Wave: Keys will light up from left to right in a wave pattern.
- Custom: You can choose which keys you want to light up. Follow these steps to customize:

1- Switch the backlight mode to custom.

2- Hold + Right until the backlight turns off.

3- Press the key or keys you want to have backlight ON.

4- When finished, press + Right again to save your custom backlight profile.







### 6KRO and NKRO rollover modes:

Key rollover is a feature allowing every key you press to be correctly registered.



6KRO is enabled by default. This allows up to 6 keys and 4 modifier keys (Windows, Alt, Ctrl, Shift) to be registered at the same time.

Switching to NKRO mode enables every key on your keyboard to be registered correctly at the same time.

Function Keys	Secondary Feature
 + 	Enables NKRO rollover mode. The Game Mode indicator will blink twice to confirm.
 + 	Enables 6KRO rollover mode. The Game Mode indicator will blink twice to confirm.

### Keyboard factory reset:

If you are experiencing any issue with the keyboard you can perform a factory reset. You will lose your custom LED profile by doing this.

Function Keys	Secondary Feature
 + 	Press both keys for 3 seconds until the keyboard backlight blinks.





# Teclado mecánico para videojuegos HyperX Alloy



Códigos de artículo		
Cherry® MX azul	Cherry® MX marrón	Cherry® MX rojo
HX-KB1BL1-NA/A3	HX-KB1BR1-RU/A5	HX-KB1RD1-RU/A5
HX-KB1BL1-LA/A4	HX-KB1BR1-DE/A2	HX-KB1RD1-DE/A2
HX-KB1BL1-RU/A5	HX-KB1BR1-LA/A4	HX-KB1RD1-LA/A4
HX-KB1BL1-NA/A1	HX-KB1BR1-NA/A1	HX-KB1RD1-NA/A1
HX-KB1BL1-DE/A2	HX-KB1BR1-NA/A2	HX-KB1RD1-NA/A2
HX-KB1BL1-NO/A2	HX-KB1BR1-NA/A3	HX-KB1RD1-NA/A3
HX-KB1BL1-UK/A2	HX-KB1BR1-NA/A4	HX-KB1RD1-NA/A4
HX-KB1BL1-NA/A4	HX-KB1BR1-NO/A2	HX-KB1RD1-NO/A2
HX-KB1BL1-NA/A2	HX-KB1BR1-UK/A2	HX-KB1RD1-UK/A2
HX-KB1BL1-FR/A2	HX-KB1BR1-FR/A2	HX-KB1RD1-FR/A2

**Elementos incluidos:**

- Teclado mecánico para videojuegos HyperX Alloy
- Cable USB extraíble
- 8x Teclas para juego
- Extractor de teclas
- Funda para viaje





## Descripción general del teclado:

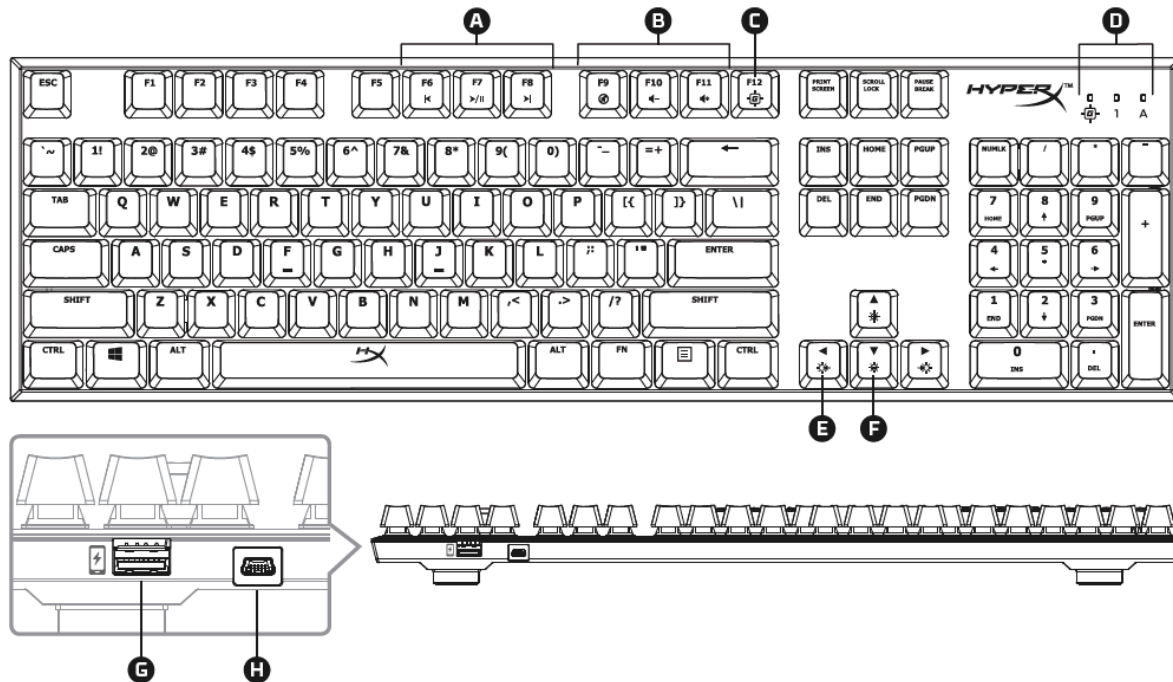

A- F6 F7 F8 = Teclas multimedia.

B- F9 F10 F11 = Teclas de control de volumen.

C- F12 = Tecla de modo Juego.

D- Indicadores de modo Juego/Bloq Num/Bloq Mayús.

E- Izquierda y Derecha = Teclas de control de modo LED.

F- Arriba y Abajo = Teclas de control de brillo LED.

G- Puerto USB posterior = Puerto de carga USB para teléfono móvil.

H- Puerto mini USB posterior = puerto de cable USB del teclado.

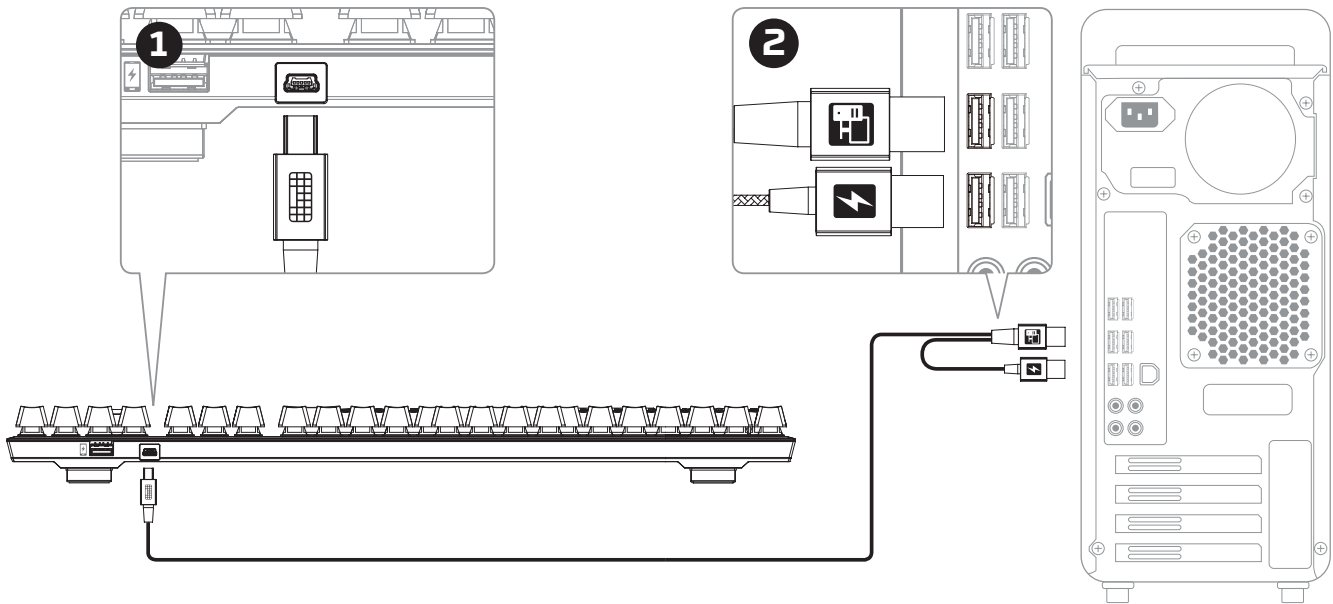
**Instalación del teclado:**

- 1- Conectar el conector mini USB al teclado.
- 2- Conectar ambos conectores USB al ordenador.



### Teclas de función:



Pulse "FN" y una tecla de función de manera simultánea para activar la función secundaria.

Teclas de función	Función secundaria
	Reproducir/poner en pausa >/  , saltar hacia atrás ◀ u saltar hacia adelante ▶ música o vídeos.
	Silenciar 🔇, bajar 🔊- o subir 🔊+ el audio del ordenador.
	Habilitar modo Juego 🎮 para desactivar la tecla Windows y evitar la interrupción accidental durante la partida. Al activar el modo Juego, el indicador se iluminará.
	Aumentar ☀+ o disminuir ☀- el brillo de la retroiluminación LED. Existen cinco niveles de brillo: Desactivado, 25 %, 50 %, 75 % y 100 %..



	<p>Cambiar entre los modos de retroiluminación LED con las siguientes teclas  / .</p>
--	---

**Modos de retroiluminación LED:**

Existen seis modos de retroiluminación LED: Sólido ► Respiración ► Desencadenante ► Explosión ► Onda ► Personalizado.

- Sólido: Iluminación constante (configuración predeterminada).
- Respiración: Parpadeo lento que imita la respiración.
- Desencadenante: Las teclas se iluminarán al pulsarlo y se apagarán gradualmente al cabo de un segundo.
- Explosión: Se emitirá un efecto de iluminación al pulsar las teclas.
- Onda: Las teclas se encenderán de izquierda a derecha como una onda.
- Personalizado: Puede elegir qué teclas desea que se enciendan. Para realizar la personalización, siga estos pasos:

1- Cambie el modo de retroiluminación a Personalizado.

2- Mantenga pulsada la tecla + Derecha hasta que se apague la retroiluminación.

3- Pulse la tecla o teclas que desea que se retroiluminen.

4- Cuando haya acabado, pulse + Derecha de nuevo para guardar su perfil de retroiluminación personalizado.



### Modos de pulsación simultánea 6KRO y NKRO:

La pulsación simultánea de teclas es una función que permite que cada tecla que pulse se registre correctamente.

6KRO está activado de forma predeterminada. Esto permite registrar al mismo tiempo hasta 6 teclas y 4 teclas modificadoras (Windows, Alt, Ctrl y Mayús).

Al cambiar al modo NKRO, permite que cada tecla de su teclado se registre correctamente al mismo tiempo.

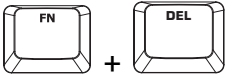
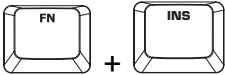
Teclas de función	Función secundaria
	Activa el modo de pulsación simultánea NKRO. El indicador del modo de juego parpadeará dos veces para confirmarlo.
	Activa el modo de pulsación simultánea 6KRO. El indicador del modo de juego parpadeará dos veces para confirmarlo.

### Restablecimiento de fábrica del teclado:

Si tiene algún problema con el teclado, puede realizar un restablecimiento de fábrica. Al hacerlo perderá su perfil LED personalizado.

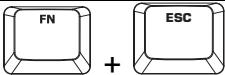
Teclas de función	Función secundaria
	Pulse ambas teclas durante 3 segundos hasta que la retroiluminación del teclado parpadee.



# HyperX Alloy FPS Mechanische Gaming-Tastatur



Artikelnummern		
Cherry® MX Blue	Cherry® MX Brown	Cherry® MX Red
HX-KB1BL1-NA/A3	HX-KB1BR1-RU/A5	HX-KB1RD1-RU/A5
HX-KB1BL1-LA/A4	HX-KB1BR1-DE/A2	HX-KB1RD1-DE/A2
HX-KB1BL1-RU/A5	HX-KB1BR1-LA/A4	HX-KB1RD1-LA/A4
HX-KB1BL1-NA/A1	HX-KB1BR1-NA/A1	HX-KB1RD1-NA/A1
HX-KB1BL1-DE/A2	HX-KB1BR1-NA/A2	HX-KB1RD1-NA/A2
HX-KB1BL1-NO/A2	HX-KB1BR1-NA/A3	HX-KB1RD1-NA/A3
HX-KB1BL1-UK/A2	HX-KB1BR1-NA/A4	HX-KB1RD1-NA/A4
HX-KB1BL1-NA/A4	HX-KB1BR1-NO/A2	HX-KB1RD1-NO/A2
HX-KB1BL1-NA/A2	HX-KB1BR1-UK/A2	HX-KB1RD1-UK/A2
HX-KB1BL1-FR/A2	HX-KB1BR1-FR/A2	HX-KB1RD1-FR/A2





### Im Lieferumfang:

- HyperX Alloy FPS Mechanische Gaming-Tastatur
- Abnehmbares USB-Kabel
- 8 Gaming-Tastenkappen
- Werkzeug zum Entfernen der Tastenkappen
- Transporttasche





## Tastenübersicht

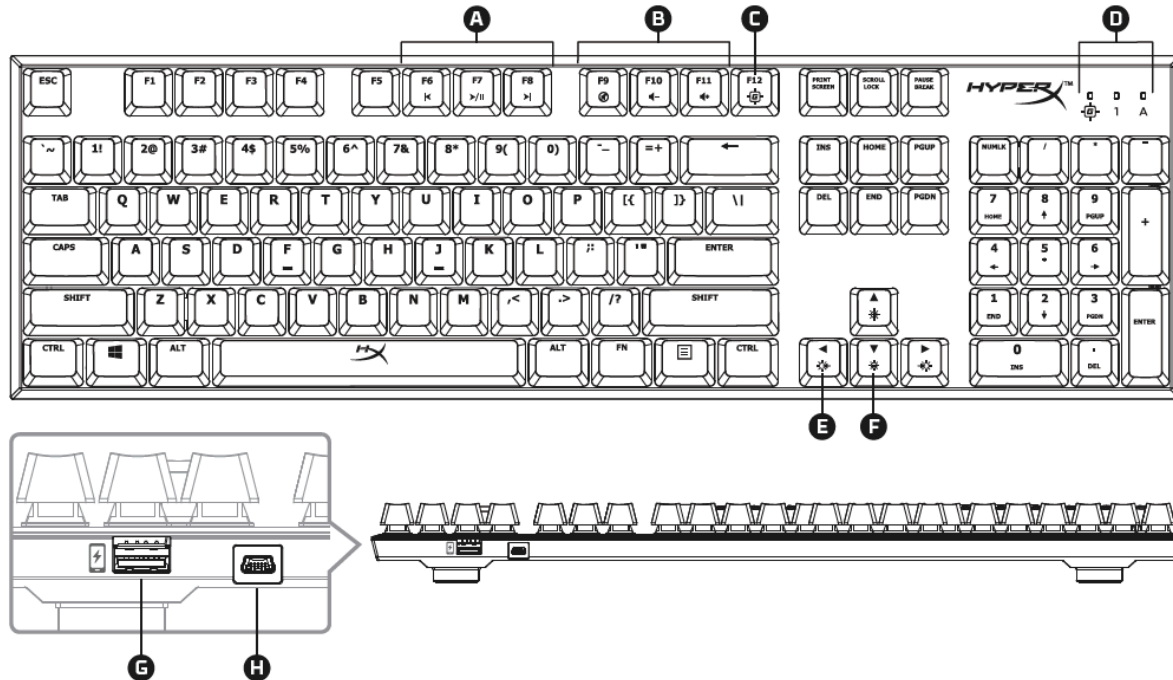

A- F6 F7 F8 = Medientasten

B- F9 F10 F11 = Lautstärketasten

C- F12 = Spielmodus-Taste

D- Anzeige für Spielmodus / Num / Feststelltaste

E- Pfeil nach links und rechts = Tasten für LED-Modus

F- Pfeil nach oben und unten = Tasten für LED-Helligkeit

G- USB-Anschluss auf der Rückseite = Handy-USB-Ladeanschluss

H- Mini-USB-Anschluss auf der Rückseite = USB-Anschluss für Tastaturkabel



## Installation der Tastatur

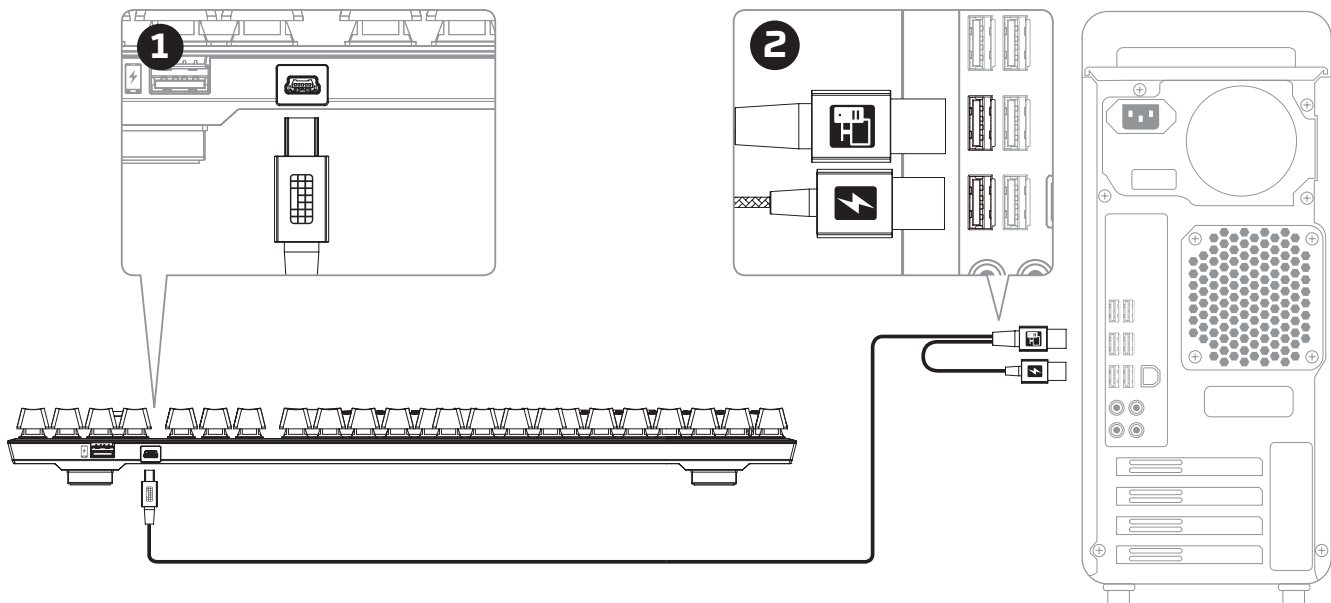

- 1- Verbinde den Mini-USB-Stecker mit der Tastatur.
- 2- Verbinde beide USB-Stecker mit dem Computer.



## Funktionstasten:



Drücke gleichzeitig auf "FN" und eine zweite Taste, um dessen Zweitfunktion zu aktivieren.

Funktionstasten	Zweitfunktion
<p style="text-align: center;">FN + F6 F7 F8  &lt; &gt; /   &gt; </p>	<p>Wiedergabe/Pause &gt; /  , nach hinten &lt; &lt; oder vorne spulen &gt;  deiner Musik oder deines Videos.</p>
<p style="text-align: center;">FN + F9 F10 F11 Ⓜ ← ←</p>	<p>Die Lautstärke deines Computers stummschalten Ⓜ, herabsetzen ←- oder erhöhen ←+.</p>
<p style="text-align: center;">FN + F12 Ⓜ</p>	<p>Aktiviere den Spielmodus Ⓜ, um die Windows-Taste zu deaktivieren und somit versehentliche Spielunterbrechungen zu vermeiden. Wenn der Spielmodus aktiv ist, leuchtet die entsprechende Anzeige.</p>
<p style="text-align: center;">FN + ↑ ↓ * *</p>	<p>Die LED-Hintergrundbeleuchtung erhöhen Ⓜ+ oder dimmen Ⓜ-. Es gibt 5 Helligkeitsstufen: AUS, 25 %, 50 %, 75 % und 100 %.</p>



	<p>Du kannst mit den folgenden Tasten zwischen den LED-Hintergrundbeleuchtungsmodi umschalten  / .</p>
--	--

### Modi für LED-Hintergrundbeleuchtung:

Es gibt sechs Modi für die LED-Hintergrundbeleuchtung: Durchgehend ► Atmung ► Auslöser ► Explosion ► Welle ► Benutzerdefiniert.

- ① Durchgehend: Konstante Beleuchtung (Standardeinstellung).
- ② Atmung: Langsames Blinken, das der Atmung nachempfunden ist.
- ③ Auslöser: Die einzelnen Tasten leuchten bei Betätigung auf, die Beleuchtung lässt nach einer Sekunde nach.
- ④ Explosion: Ein Lichteffekt geht bei Betätigung von den einzelnen Tasten aus.
- ⑤ Welle: Die Tasten leuchten wellenartig von links nach rechts auf.
- ⑥ Benutzerdefiniert: Du legst fest, welche Tasten beleuchtet werden. Führe die folgenden Schritte aus, um die Beleuchtung anzupassen:

1- Schalte die Hintergrundbeleuchtung in den Modus „Benutzerdefiniert“.

2- Drücke + Rechts , bis die Hintergrundbeleuchtung ausgeht.

3- Drücke die Taste bzw. die Tasten, für die Du die Hintergrundbeleuchtung einschalten möchtest.

4- Wenn du fertig bist, drücke erneut auf + Rechts , um deine Einstellungen zu speichern.



### 6KRO und NKRO Rollover-Modi:

Key-Rollover ist eine Funktion, durch die jede gedrückte Taste korrekt erfasst wird.

Der 6KRO-Modus ist standardmäßig aktiv. Dadurch können bis zu 6 Tasten und vier Tasten für Zusatzfunktionen (Windows, Alt, Ctrl, Shift) gleichzeitig registriert werden.

Wenn du in den NKRO-Modus wechselst, wird jede Taste auf Ihrer Tastatur gleichzeitig richtig erkannt.

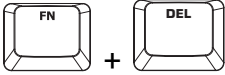
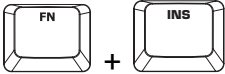
Funktionstasten	Zweitfunktion
	Aktiviert den NKRO-Rollover-Modus. Die Game-Modus-Anzeige blinkt zur Bestätigung zweimal auf.
	Aktiviert den 6KRO-Rollover-Modus. Die Game-Modus-Anzeige blinkt zur Bestätigung zweimal auf.

### Werkeinstellungen für Tastatur

Wenn du Probleme mit deiner Tastatur bekommst, kannst du sie auf die Werkeinstellungen zurücksetzen. Dadurch gehen deine individuellen LED-Einstellungen verloren.

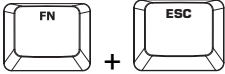
Funktionstasten	Zweitfunktion
	Drücke beide Tasten 3 Sekunden lang, bis die Hintergrundbeleuchtung der Tastatur blinkt.



# Clavier de jeu mécanique HyperX Alloy FPS



## Références des pièces

Cherry® MX Blue	Cherry® MX Brown	Cherry® MX Red
HX-KB1BL1-NA/A3	HX-KB1BR1-RU/A5	HX-KB1RD1-RU/A5
HX-KB1BL1-LA/A4	HX-KB1BR1-DE/A2	HX-KB1RD1-DE/A2
HX-KB1BL1-RU/A5	HX-KB1BR1-LA/A4	HX-KB1RD1-LA/A4
HX-KB1BL1-NA/A1	HX-KB1BR1-NA/A1	HX-KB1RD1-NA/A1
HX-KB1BL1-DE/A2	HX-KB1BR1-NA/A2	HX-KB1RD1-NA/A2
HX-KB1BL1-NO/A2	HX-KB1BR1-NA/A3	HX-KB1RD1-NA/A3
HX-KB1BL1-UK/A2	HX-KB1BR1-NA/A4	HX-KB1RD1-NA/A4
HX-KB1BL1-NA/A4	HX-KB1BR1-NO/A2	HX-KB1RD1-NO/A2
HX-KB1BL1-NA/A2	HX-KB1BR1-UK/A2	HX-KB1RD1-UK/A2
HX-KB1BL1-FR/A2	HX-KB1BR1-FR/A2	HX-KB1RD1-FR/A2



## Le produit inclut :

- Clavier de jeu mécanique HyperX Alloy FPS
- Cordon USB amovible
- 8 touches de rechange
- Clé de démontage des touches
- Housse de transport







## Présentation du clavier :

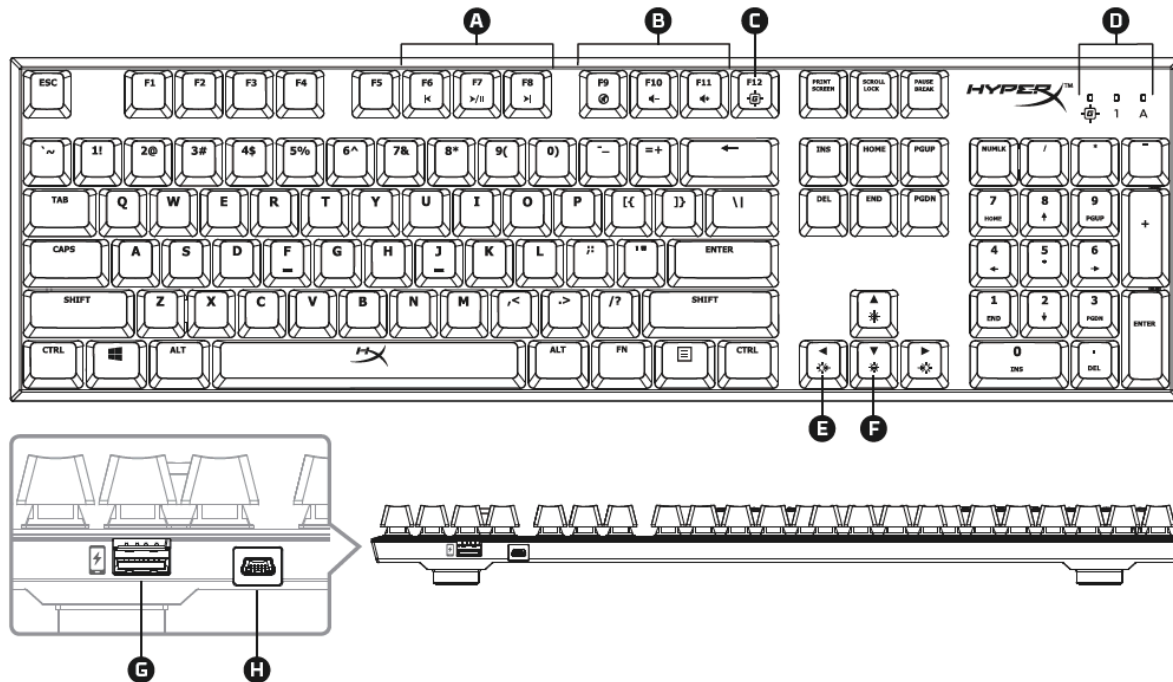

A- F6 F7 F8 = Touches médias.

B- F9 F10 F11 = Touches de réglage du volume.

C- F12 = Touche d'activation du mode Jeu.

D- Témoins lumineux : Mode Jeu / Verrouillage du clavier numérique / Verrouillage de la touche Majuscule.

E- Gauche & Droite = Touches de contrôle du mode LED.

F- Haut & Bas = Touches de réglage de la luminosité LED.

G- Port USB arrière = Port de chargement USB pour téléphone portable.

H- Port Mini USB arrière = Port de connexion pour câble de clavier USB.

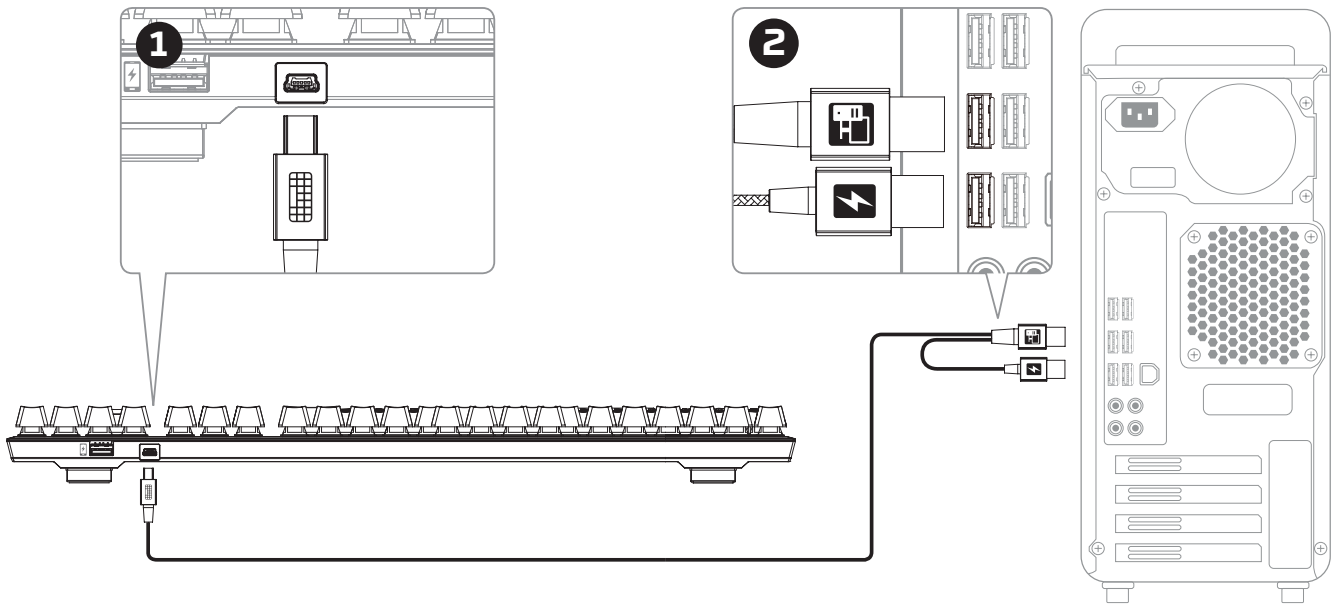
**Installation du clavier :**

- 1- Branchez le connecteur Mini USB au clavier.
- 2- Branchez les deux connecteurs USB à l'ordinateur.



## Touches de fonction :



Appuyez en même temps sur la touche FN et sur une touche de fonction pour activer sa fonction secondaire.

Touches de fonction	Fonction secondaire
	<p>Lecture/pause &gt;/  , Retour rapide &lt; ou Avance rapide &gt; pendant la lecture d'un fichier audio ou vidéo.</p>
	<p>Couper , Diminuer  ou Augmenter  le volume audio de votre ordinateur.</p>
	<p>Activer le mode Jeu  pour désactiver la touche Windows et éviter des interruptions accidentelles pendant les jeux. Lorsque le mode Jeu est activé, le voyant Jeu est allumé.</p>
	<p>Augmenter  ou diminuer  la luminosité du rétroéclairage LED. Il existe cinq niveaux de luminosité : ÉTEINT, 25%, 50%, 75% et 100%.</p>



	<p>Sélectionner un des modes de rétroéclairage LED avec les touches suivantes  / .</p>
--	--

### Mode de rétroéclairage LED :

Six modes de rétroéclairage LED sont disponibles : Fixe ► Respiration ► Déclenchement ► Explosion ► Onde ► Personnalisation.

Fixe : Éclairage constant (valeur par défaut).

Respiration : Clignotement lent qui imite la respiration.

Déclenchement : Les touches s'allument individuellement lorsqu'elles sont pressées et s'éteignent progressivement après une seconde.

Explosion : Un effet lumineux rayonne à chaque pression sur une touche.

Onde : Les touches s'allument de gauche à droite en formant une onde lumineuse.

Personnalisation : Vous choisissez les touches qui doivent s'allumer. Pour personnaliser, suivez les instructions ci-dessous :

1- Activez le mode d'éclairage Personnalisation.

2- Appuyez sur la touche + Droite jusqu'à ce que le rétroéclairage s'éteigne.

3- Appuyez sur la touche ou les touches pour lesquelles vous souhaitez activer le rétroéclairage.

4- Lorsque vous avez terminé, appuyez à nouveau sur la touche + Droite pour enregistrer votre configuration du rétroéclairage personnalisé.







### Modes Rollover 6KRO et NKRO :

Le Rollover est une fonction qui garantit l'exécution correcte de chaque touche sélectionnée.



6KRO est activé par défaut. Ce mode offre jusqu'à 6 touches et 4 touches de modification (Windows, Alt, Ctrl, Maj.) simultanément enregistrées.

En mode NKRO, chaque touche du clavier est enregistrée correctement et simultanément.

Touches de fonction	Fonction secondaire
 + 	Active le mode Rollover NKRO. L'indicateur du Mode de jeu clignote deux fois pour confirmer.
 + 	Active le mode Rollover 6KRO. L'indicateur du Mode de jeu clignote deux fois pour confirmer.

### Réinitialisation d'usine :

Si vous rencontrez un problème pendant l'utilisation du clavier, vous pouvez le réinitialiser pour rétablir sa configuration d'usine. Cette réinitialisation efface tous les paramètres de personnalisation LED.

Touches de fonction	Fonction secondaire
 + 	Maintenez les deux touches enfoncées pendant 3 secondes jusqu'à ce que le rétroéclairage du clavier clignote.



# Tastiera meccanica per il gaming HyperX Alloy FPS



Numeri di parte		
Cherry® MX Blue	Cherry® MX Brown	Cherry® MX Red
HX-KB1BL1-NA/A3	HX-KB1BR1-RU/A5	HX-KB1RD1-RU/A5
HX-KB1BL1-LA/A4	HX-KB1BR1-DE/A2	HX-KB1RD1-DE/A2
HX-KB1BL1-RU/A5	HX-KB1BR1-LA/A4	HX-KB1RD1-LA/A4
HX-KB1BL1-NA/A1	HX-KB1BR1-NA/A1	HX-KB1RD1-NA/A1
HX-KB1BL1-DE/A2	HX-KB1BR1-NA/A2	HX-KB1RD1-NA/A2
HX-KB1BL1-NO/A2	HX-KB1BR1-NA/A3	HX-KB1RD1-NA/A3
HX-KB1BL1-UK/A2	HX-KB1BR1-NA/A4	HX-KB1RD1-NA/A4
HX-KB1BL1-NA/A4	HX-KB1BR1-NO/A2	HX-KB1RD1-NO/A2
HX-KB1BL1-NA/A2	HX-KB1BR1-UK/A2	HX-KB1RD1-UK/A2
HX-KB1BL1-FR/A2	HX-KB1BR1-FR/A2	HX-KB1RD1-FR/A2

**Contenuto della confezione:**

- Tastiera meccanica per il gaming HyperX Alloy FPS
- Cavo USB scollegabile
- 8 copritasti per gaming
- Estrattore copritasti
- Custodia da viaggio





## Panoramica sulla tastiera:

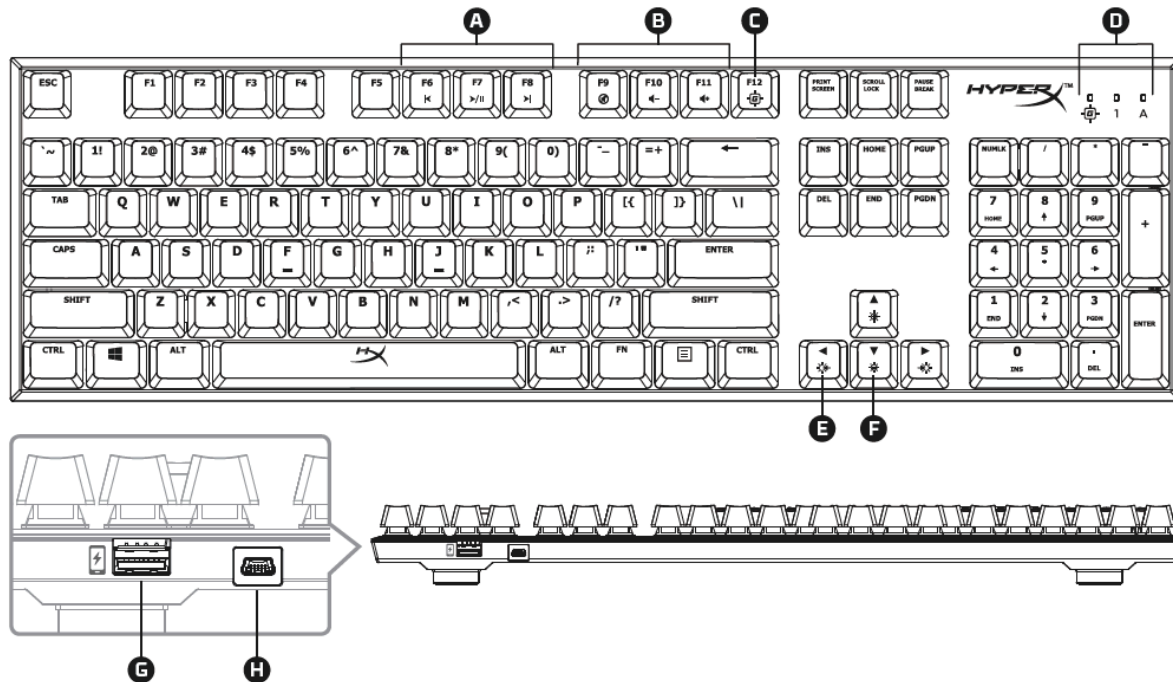

A- F6 F7 F8 = tasti multimediali.

B- F9 F10 F11 = tasti per la regolazione del volume.

C- F12 = tasto modalità Game.

D- Indicatori Modalità Game / Bloc Num / Bloc Maiusc.

E- Sinistra / Destra = tasti di controllo modalità LED.

F- Su / Giù = tasti di regolazione luminosità LED.

G- Porta USB posteriore = porta USB per la ricarica di smartphone.

H- Porta mini USB posteriore = porta per il cavo USB della tastiera.

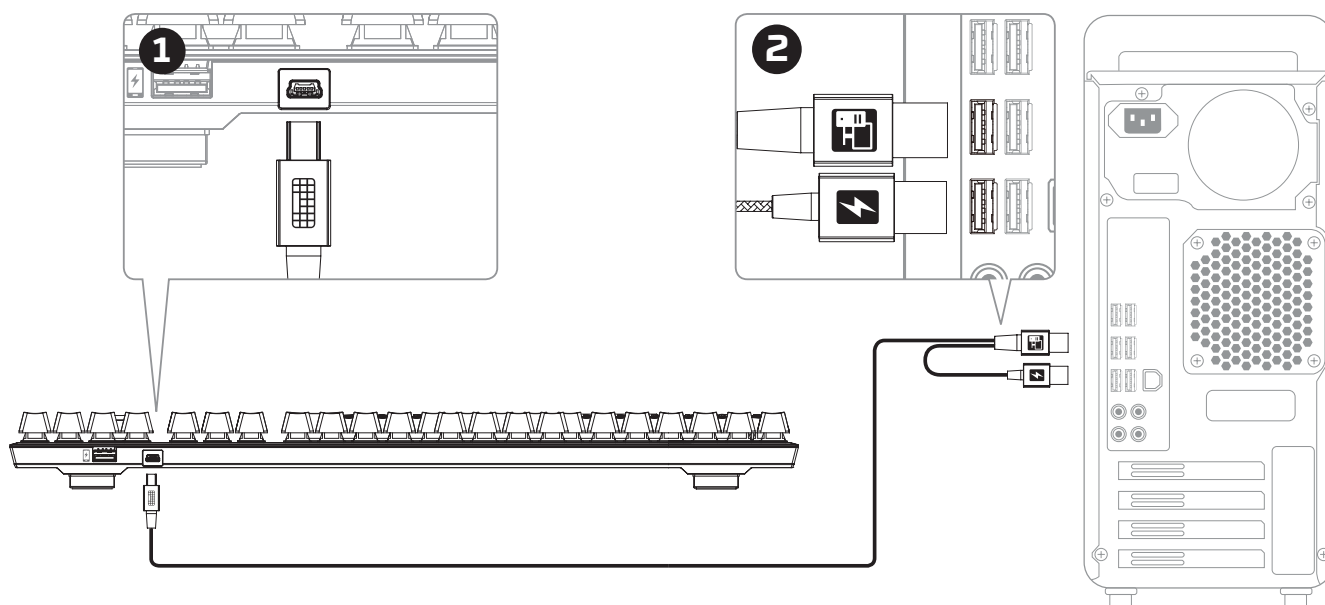

**Installazione rapida:**











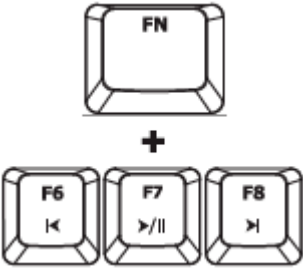

- 1- Inserire il connettore mini USB nella tastiera.
- 2- Inserire entrambi i connettori USB nel computer.

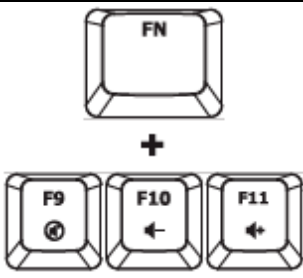

### Tasti funzione:

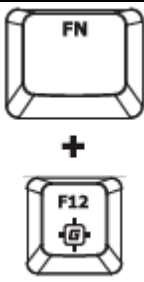

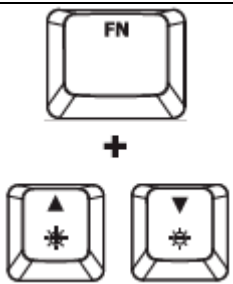
Premere il tasto “FN” contemporaneamente a uno dei tasti funzione per attivarne la funzionalità prevista.

Tasti funzione	Funzionalità prevista
	<p>Play/pausa , salta indietro  o salta avanti  in caso di musica o video.</p>
	<p>Silenza , riduce  o aumenta  l'audio del computer.</p>
	<p>Attiva modalità Mode  per disattivare il tasto Windows ed evitare interruzioni involontarie del gioco. L'indicatore si illumina quando la modalità Game è attivata.</p>
	<p>Aumenta  o riduce  la luminosità della retroilluminazione LED. Sono previsti 5 livelli di luminosità: Spento, 25%, 50%, 75% e 100%.</p>



	<p>È possibile passare tra le diverse modalità di illuminazione LED utilizzando i tasti  / .</p>
--	--

### Modalità retroilluminazione LED:

Sono previsti 6 modalità di retroilluminazione LED: Fissa ► Respiro ► Pressione ► Esplosione ► Onda ► Personalizzato.

Fissa: illuminazione costante (impostazioni di default).

Respiro: lampeggio lento che ricorda l'immagine di un respiro.

Pressione: i singoli tasti si illuminano appena premuti per poi spegnersi lentamente dopo la pressione.

Esplosione: da ogni tasto premuto parte un effetto luminoso che si irradia in tutte le direzioni.

Onda: i tasti si illuminano insieme da sinistra verso destra, simulando il passaggio di un'onda.

Personalizzato: è possibile decidere quali tasti illuminare. Per eseguire la personalizzazione:

1- Passare alla modalità Personalizzato

2- Tenere premuto + il tasto destro, fino a quando verrà disattivata la retroilluminazione.

3- Premere il tasto o i tasti per cui si desidera attivare la retroilluminazione.

4- Al termine, premere nuovamente + il tasto destro, per salvare il profilo di retroilluminazione personalizzato.



### Modalità di rollover 6KRO e NKRO:

Il rollover dei tasti è una funzione che consente di registrare in modo corretto ogni singolo tasto premuto.

La modalità 6KRO è attiva per impostazione predefinita. Questa modalità consente di registrare contemporaneamente fino a 6 tasti normali e 4 tasti funzione (Windows, Alt, Ctrl, Maiusc).

Passando alla modalità NKRO è possibile premere tutti i tasti della tastiera che saranno registrati correttamente in contemporanea.

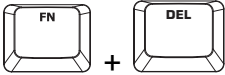
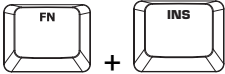
Tasti funzione	Funzionalità prevista
	Attiva la modalità di rollover NKRO. L'indicatore della modalità Game lampeggerà due volte per confermare l'attivazione.
	Attiva la modalità di rollover 6KRO. L'indicatore della modalità Game lampeggerà due volte per confermare l'attivazione.

### Ripristino opzioni di fabbrica:

Nel caso si verificano problemi nell'utilizzo della tastiera, è possibile ripristinare le opzioni di fabbrica. In questo caso, tutte le impostazioni di personalizzazione del profilo LED saranno eliminate.

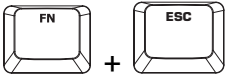
Tasti funzione	Funzionalità prevista
	Premere entrambi i tasti per 3 secondi fino a quando la retroilluminazione della tastiera inizierà a lampeggiare.



# Teclado mecânico para jogos Alloy FPS HyperX



<b>Código do Produto</b>		
<b>Cherry® MX Blue</b>	<b>Cherry® MX Brown</b>	<b>Cherry® MX Red</b>
HX-KB1BL1-NA/A3	HX-KB1BR1-RU/A5	HX-KB1RD1-RU/A5
HX-KB1BL1-LA/A4	HX-KB1BR1-DE/A2	HX-KB1RD1-DE/A2
HX-KB1BL1-RU/A5	HX-KB1BR1-LA/A4	HX-KB1RD1-LA/A4
HX-KB1BL1-NA/A1	HX-KB1BR1-NA/A1	HX-KB1RD1-NA/A1
HX-KB1BL1-DE/A2	HX-KB1BR1-NA/A2	HX-KB1RD1-NA/A2
HX-KB1BL1-NO/A2	HX-KB1BR1-NA/A3	HX-KB1RD1-NA/A3
HX-KB1BL1-UK/A2	HX-KB1BR1-NA/A4	HX-KB1RD1-NA/A4
HX-KB1BL1-NA/A4	HX-KB1BR1-NO/A2	HX-KB1RD1-NO/A2
HX-KB1BL1-NA/A2	HX-KB1BR1-UK/A2	HX-KB1RD1-UK/A2
HX-KB1BL1-FR/A2	HX-KB1BR1-FR/A2	HX-KB1RD1-FR/A2

**O que está incluído:**

- Teclado mecânico para jogos Alloy FPS HyperX
- Cabo USB removível
- 8 capas de teclas para jogos
- Ferramenta para retirar capas de teclas
- Bolsa de viagem





## Visão Geral do teclado:

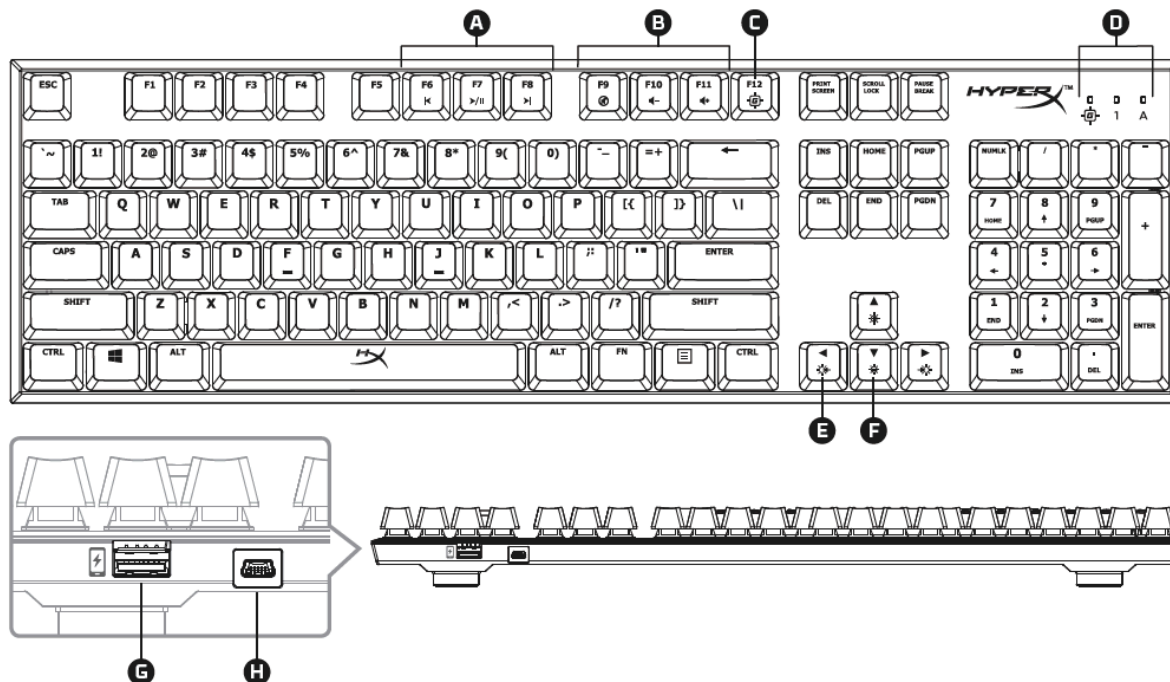

A- F6 F7 F8 = Teclas de mídia.

B- F9 F10 F11 = Teclas de controle de volume.

C- F12 = Tecla de modo jogo.

D- Indicadores Modo jogo / Num Lock / Caps Lock.

E- Seta para esquerda e para direita = teclas de controle do modo LED.

F- Seta para cima e para baixo = teclas de controle de brilho do LED.

G- Porta USB posterior = Porta USB de carregamento de celular.

H- Porta Mini USB posterior = Porta do cabo USB do teclado.



## Instalação do teclado:

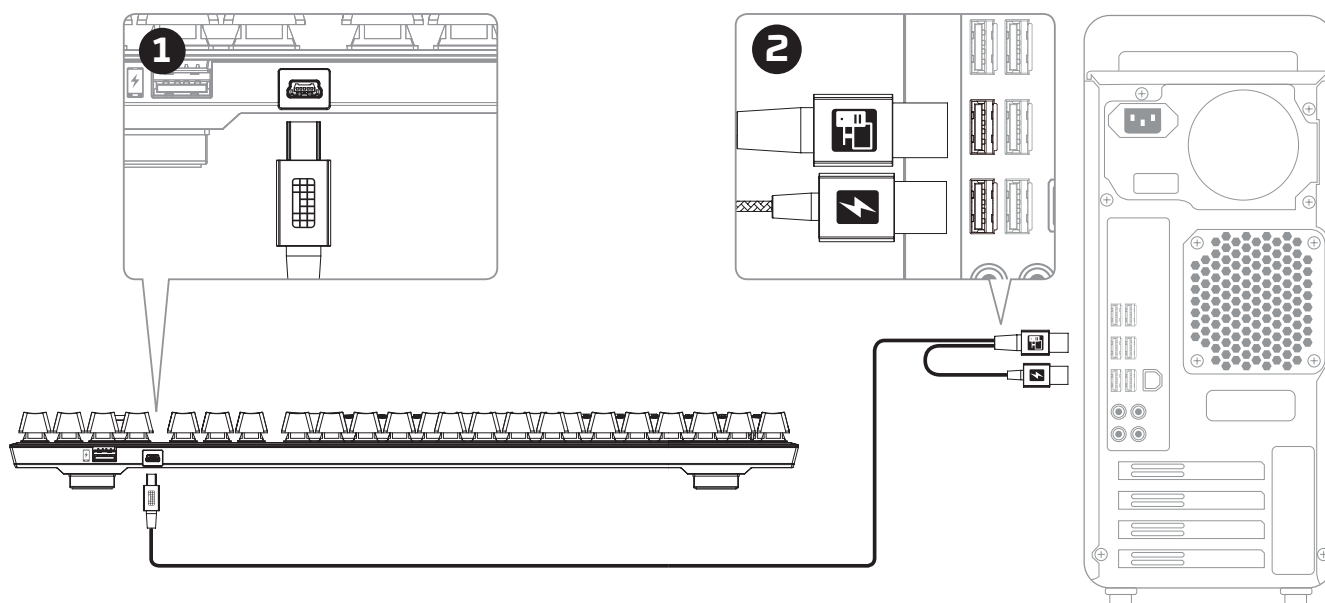

- 1- Conecte o conector Mini USB ao teclado.
- 2- Conecte ambos os conectores USB ao computador.





### Teclas de função:



Pressione “FN” e uma tecla de função ao mesmo tempo para ativar seu recurso secundário.

Teclas de função	Recurso secundário
<p>FN +</p> <p>F6 F7 F8 ◀ ▶/   ▶</p>	<p>Reproduzir/pausar ▶/  , retroceder ◀ ou avançar ▶ para ouvir música ou assistir vídeos.</p>
<p>FN +</p> <p>F9 F10 F11 Ⓜ ← ←</p>	<p>Mudo 🗣️, diminuir 🔊- ou aumentar 🔊+ o áudio do seu computador.</p>
<p>FN +</p> <p>F12 Ⓜ</p>	<p>Ativar modo jogo 🎮 para desativar a tecla Windows e evitar interrupção acidental durante o jogo. Quando o modo jogo está ativado, o indicador se ilumina.</p>
<p>FN +</p> <p>▲ ✨ ▼ ✨</p>	<p>Aumentar ☀️ ou diminuir ☀️ o brilho de backlight do LED. Há 5 níveis de brilho: DESL, 25%, 50%, 75% e 100%.</p>



	<p>Altere entre os modos de backlight do LED com as seguintes teclas  / .</p>
--	---

### Modos de backlight do LED:

Há seis modos de backlight do LED: Sólido ► Respiração ► Acionamento ► Explosão ► Onda ► Personalizado.

Sólido: Iluminação constante (configuração padrão).

Respiração: Piscar lento imitando a respiração.

Acionamento: Teclas individuais se acendem quando pressionadas e desaparecem lentamente após um segundo.

Explosão: Um efeito de luz se irradia de teclas individuais quando pressionadas.

Onda: As teclas se acendem da esquerda para a direita em forma de onda.

Personalizado: Você pode escolher quais teclas deseja acender. Siga estes passos para personalizar:

1- Coloque o modo backlight em Personalizado.

2- Mantenha pressionado + Direita até desligar o backlight.

3- Pressione a tecla ou teclas que deseja o backlight LIGADO.

4- Quando terminar, pressione + Direita novamente para salvar seu perfil de backlight personalizado.



### Modos de rollover 6KRO e NKRO:

Rollover de tecla é um recurso que permite que todas as teclas pressionadas sejam corretamente registradas.

O modo 6KRO vem ativado por padrão. Isso permite que até 6 teclas e 4 teclas modificadoras (Windows, Alt, Ctrl, Shift) sejam registradas ao mesmo tempo.

Alternando para o modo NKRO permite que todas as teclas de seu teclado sejam registradas corretamente ao mesmo tempo.

Teclas de função	Recurso secundário
	Ativa o modo NKRO de rollover. O indicador de Modo de Jogo irá piscar duas vezes para confirmar.
	Ativa o modo 6KRO de rollover. O indicador de Modo de Jogo irá piscar duas vezes para confirmar.

### Retornar o teclado às configurações de fábrica:

Se está tendo algum problema com o teclado você pode retornar às configurações de fábrica. Ao fazer isso você perderá seu perfil de LED personalizado.

Teclas de função	Recurso secundário
	Pressione ambas as teclas por 3 segundos até o backlight do teclado piscar.



# HyperX Alloy FPS – mechaniczna klawiatura dla graczy



Numery katalogowe		
Cherry® MX Blue	Cherry® MX Brown	Cherry® MX Red
HX-KB1BL1-NA/A3	HX-KB1BR1-RU/A5	HX-KB1RD1-RU/A5
HX-KB1BL1-LA/A4	HX-KB1BR1-DE/A2	HX-KB1RD1-DE/A2
HX-KB1BL1-RU/A5	HX-KB1BR1-LA/A4	HX-KB1RD1-LA/A4
HX-KB1BL1-NA/A1	HX-KB1BR1-NA/A1	HX-KB1RD1-NA/A1
HX-KB1BL1-DE/A2	HX-KB1BR1-NA/A2	HX-KB1RD1-NA/A2
HX-KB1BL1-NO/A2	HX-KB1BR1-NA/A3	HX-KB1RD1-NA/A3
HX-KB1BL1-UK/A2	HX-KB1BR1-NA/A4	HX-KB1RD1-NA/A4
HX-KB1BL1-NA/A4	HX-KB1BR1-NO/A2	HX-KB1RD1-NO/A2
HX-KB1BL1-NA/A2	HX-KB1BR1-UK/A2	HX-KB1RD1-UK/A2
HX-KB1BL1-FR/A2	HX-KB1BR1-FR/A2	HX-KB1RD1-FR/A2



### Zawartość zestawu:

- HyperX Alloy FPS – mechaniczna klawiatura dla graczy
- Odłączany przewód USB
- 8 gamingowych nakładek na klawisze
- Przyrząd do zdejmowania nakładek
- Torba transportowa





## Prezentacja klawiatury:

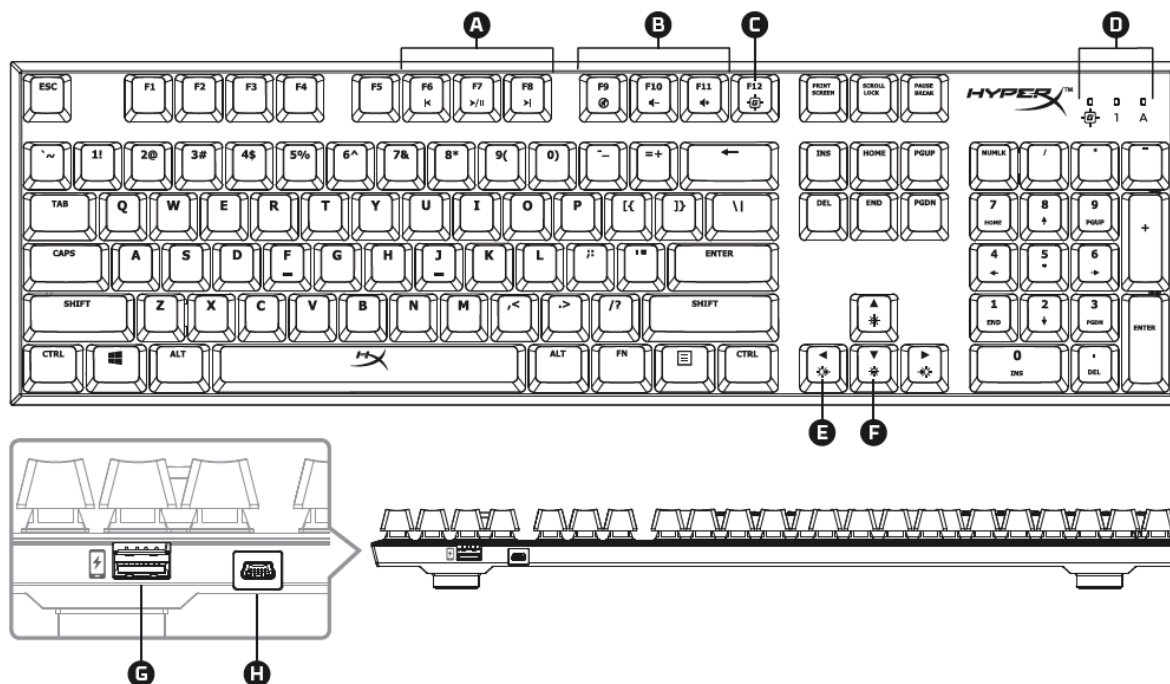

A- F6 F7 F8 = klawisze multimedialne

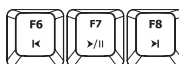

B- F9 F10 F11 = klawisze sterowania głośnością

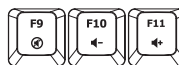

C- F12 = klawisz trybu gry



D- Wskaźniki trybu gry / Num Lock / Caps Lock



E- Strzałki lewo i prawo = sterowanie trybem podświetlenia LED

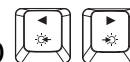

F- Strzałki góra i dół = sterowanie jasnością podświetlenia LED



G- Tylny port USB = port USB do ładowania telefonu

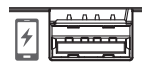

H- Tylny port mini USB = port przewodu USB klawiatury





## Instalacja klawiatury:

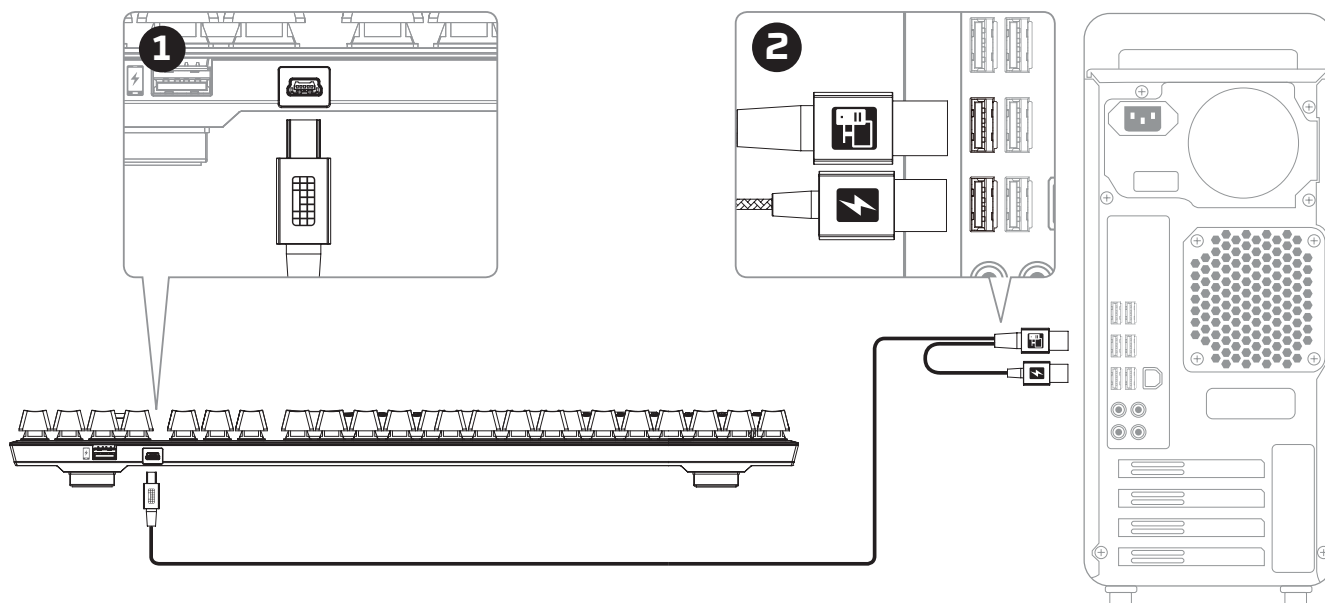

- 1- Podłącz wtyk mini USB do klawiatury.
- 2- Podłącz oba wtyki USB do komputera.

## Klawisze funkcyjne:



Naciśnij jednocześnie klawisz FN i klawisz funkcyjny, aby aktywować jego dodatkową funkcję.

Klawisze funkcyjne	Funkcja dodatkowa
 + 	Odtwarzaj / Wstrzymaj ▶/  , przejdź do tyłu ◀ lub przejdź do przodu ▶ podczas odtwarzania muzyki lub filmu.
 + 	Wycisz 🔇, zmniejsz 🔊- lub zwiększ głośność 🔊+ dźwięków z komputera.
 + 	Włącz tryb gry 🎮, aby wyłączyć klawisz Windows i zapobiec niezamierzonym przerwom w grze. Włączenie trybu gry potwierdza zapalenie się wskaźnika.
 + 	Zwiększ 🔆+ lub zmniejsz jasność 🔆- podświetlenia LED. Dostępne jest pięć poziomów jasności podświetlenia: wyłączone, 25%, 50%, 75% i 100%.



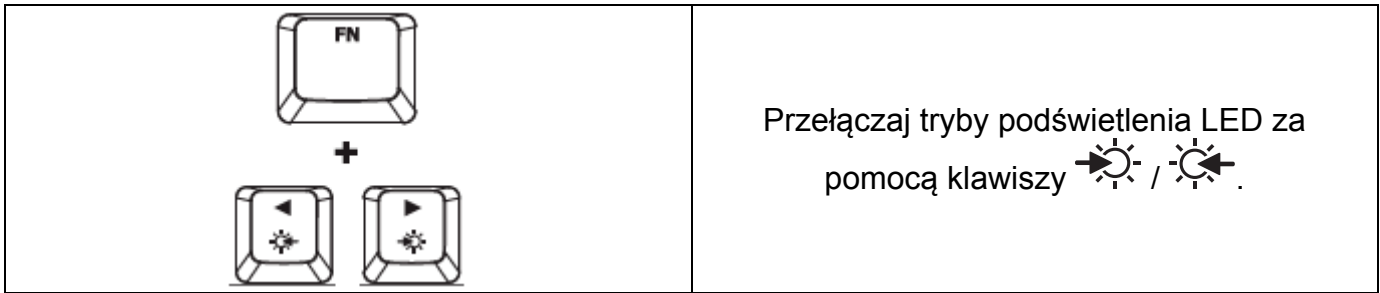

### Tryby podświetlenia LED:

Dostępne jest sześć trybów podświetlenia LED: Stałe ► Oddech ► Spust ► Eksplozja ► Fala ► Użytkownika.



1- Stałe: ciągłe podświetlenie (ustawienie domyślne).



2- Oddech: powolne pulsowanie naśladujące oddech.



3- Spust: podświetlanie naciskanych klawiszy, powoli ciemniejące po upływie sekundy.



4- Eksplozja: efekt podświetlenia rozchodzącego się od naciskanych klawiszy.



5- Fala: podświetlanie klawiszy od lewej do prawej w formie fali.





6- Użytkownika: możliwość wyboru podświetlanych klawiszy. Aby określić podświetlane klawisze, wykonaj następujące czynności:

1- Ustaw tryb podświetlenia użytkownika.

2- Naciśnij i przytrzymaj  + prawy  do chwili wyłączenia podświetlenia.

3- Naciśnij klawisz lub klawisze, które mają być podświetlone.

4- Po zakończeniu ponownie naciśnij i przytrzymaj  + prawy , aby zapisać swoje ustawienia podświetlenia.



### Tryby 6KRO i NKRO Rollover:

„Key rollover” to funkcja umożliwiająca poprawną rejestrację każdego naciśniętego klawisza.

Domyślnie włączony jest tryb 6KRO. W tym trybie można prawidłowo zarejestrować jednoczesne naciśnięcie do 6 klawiszy i 4 klawiszy modyfikujących (Windows, Alt, Ctrl, Shift).

Włączenie trybu NKRO umożliwia prawidłowe rejestrowanie jednoczesnego naciśnięcia dowolnej liczby klawiszy.

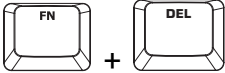
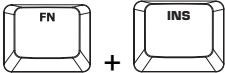
Klawisze funkcyjne	Funkcja dodatkowa
	Aktywacja trybu NKRO Rollover. Potwierdzenie dwukrotnym zaświeceniem wskaźnika trybu gry
	Aktywacja trybu 6KRO Rollover. Potwierdzenie dwukrotnym zaświeceniem wskaźnika trybu gry

### Przywracanie ustawień fabrycznych klawiatury:

W przypadku wystąpienia jakichkolwiek problemów w działaniu klawiatury można przywrócić jej ustawienia fabryczne. Spowoduje to usunięcie ustawień podświetlenia LED skonfigurowanych przez użytkownika.

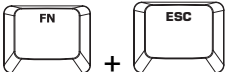
Klawisze funkcyjne	Funkcja dodatkowa
	Naciśnij i przytrzymaj oba klawisze przez 3 sekundy do chwili zapalenia się podświetlenia klawiatury.



# Механическая геймерская клавиатура HyperX Alloy FPS



Номера по каталогу		
Cherry® MX Blue	Cherry® MX Brown	Cherry® MX Red
HX-KB1BL1-NA/A3	HX-KB1BR1-RU/A5	HX-KB1RD1-RU/A5
HX-KB1BL1-LA/A4	HX-KB1BR1-DE/A2	HX-KB1RD1-DE/A2
HX-KB1BL1-RU/A5	HX-KB1BR1-LA/A4	HX-KB1RD1-LA/A4
HX-KB1BL1-NA/A1	HX-KB1BR1-NA/A1	HX-KB1RD1-NA/A1
HX-KB1BL1-DE/A2	HX-KB1BR1-NA/A2	HX-KB1RD1-NA/A2
HX-KB1BL1-NO/A2	HX-KB1BR1-NA/A3	HX-KB1RD1-NA/A3
HX-KB1BL1-UK/A2	HX-KB1BR1-NA/A4	HX-KB1RD1-NA/A4
HX-KB1BL1-NA/A4	HX-KB1BR1-NO/A2	HX-KB1RD1-NO/A2
HX-KB1BL1-NA/A2	HX-KB1BR1-UK/A2	HX-KB1RD1-UK/A2
HX-KB1BL1-FR/A2	HX-KB1BR1-FR/A2	HX-KB1RD1-FR/A2

**Комплект поставки:**

- Механическая геймерская клавиатура HyperX Alloy FPS
- Съёмный USB-кабель
- 8 игровых колпачков для клавиш
- Съёмник для колпачков клавиш
- Дорожный чехол





## Обзор клавиатуры:

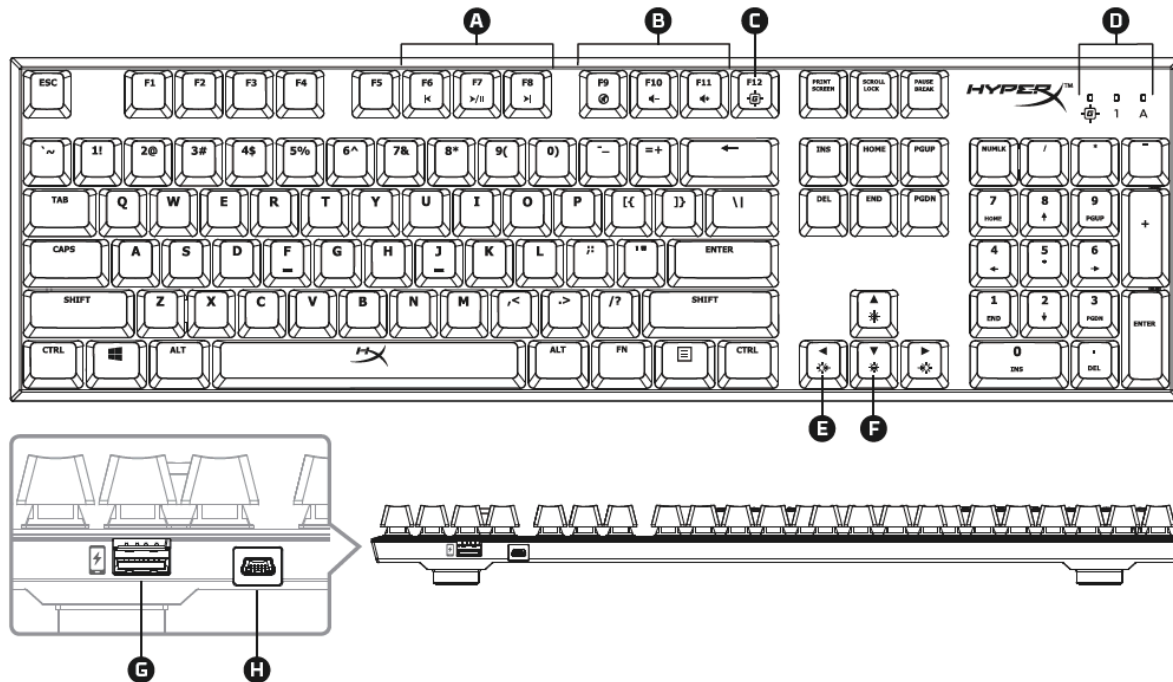

A- F6, F7, F8 = клавиши управления мультимедиа.

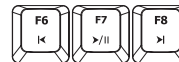

B- F9, F10, F11 = клавиши регулировки громкости.



C- F12 = клавиша игрового режима.



D- Индикаторы игрового режима/Num Lock/Caps Lock.



E- Стрелки влево и вправо = клавиши переключения режимов работы светодиодов.



F- Стрелки вверх и вниз = клавиши регулировки яркости светодиодов.



G- Задний порт USB = USB-порт для зарядки мобильных телефонов.



H- Задний порт mini-USB = порт для USB-кабеля клавиатуры.





## Установка клавиатуры:

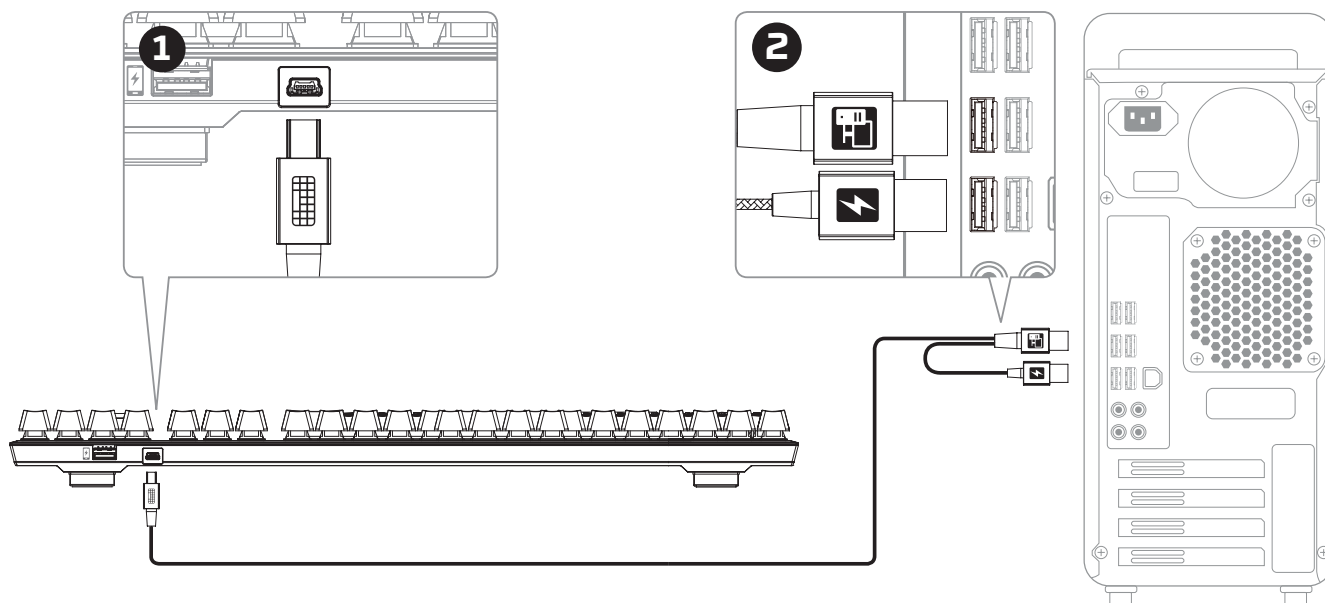

- 1- Подсоедините разъем mini-USB к клавиатуре.
- 2- Подсоедините оба разъема USB к компьютеру.



### Функциональные клавиши:



Для активации вспомогательной функции одновременно нажмите FN и функциональную клавишу.

Функциональные клавиши	Вспомогательная функция
<p style="text-align: center;">FN + F6 F7 F8  &lt; &gt;/   &gt; </p>	<p>Воспроизведение/пауза &gt;/  , прокрутка назад &lt;  или прокрутка вперед &gt;  музыки или видео.</p>
<p style="text-align: center;">FN + F9 F10 F11  &lt; &lt; &lt;</p>	<p>Выключение звука &lt; , уменьшение громкости &lt;  или увеличение громкости &lt;+ звука компьютера.</p>
<p style="text-align: center;">FN + F12  &lt; &lt;</p>	<p>Включите игровой режим &lt;  для отключения клавиши Windows и предотвращения случайного прерывания игры. При включении игрового режима загорается индикатор.</p>
<p style="text-align: center;">FN + ▲ ▼</p>	<p>Увеличение &lt;+ или уменьшение &lt;- яркости светодиодной подсветки. Имеется 5 уровней яркости: ВЫКЛ, 25%, 50%, 75% и 100%.</p>



	<p>Переключение между режимами светодиодной подсветки осуществляется с помощью клавиш  / .</p>
--	--

### Режимы светодиодной подсветки:

Имеется шесть режимов светодиодной подсветки: Постоянный ► Прерывистый ► Срабатываемый ► Вспышка ► Волнообразный ► Пользовательский.



1- Постоянный: Постоянное свечение (настройка по умолчанию).



2- Прерывистый: Медленное мигание, имитирующее дыхание.



3- Срабатываемый: Отдельные клавиши загораются при нажатии и медленно потухают через одну секунду.



4- Вспышка: Световой эффект при нажатии отдельных клавиш.



5- Волнообразный: Клавиши подсвечиваются слева направо в виде волны.



6- Пользовательский: Вы можете выбрать, для каких клавиш вам нужна подсветка. Для настройки пользовательского режима выполните следующие действия:

1- Переключите режим подсветки в пользовательский режим.

2- Удерживайте + стрелка вправо , пока подсветка не отключится.

3- Нажмите одну или несколько клавиш, для которых вы хотите включить подсветку.

4- Затем нажмите + стрелка вправо снова, чтобы сохранить свой индивидуальный профиль подсветки.









### Режимы 6KRO Rollover и NKRO Rollover:

Key Rollover – это функция, позволяющая правильно регистрировать каждое нажатие клавиш.



По умолчанию включается режим 6KRO. Это позволяет одновременно регистрировать до 6 клавиш и 4 клавишных модификаторов (Windows, Alt, Ctrl, Shift).

Переключение в режим NKRO позволяет одновременно правильно регистрировать каждое нажатие клавиши на клавиатуре.

Функциональные клавиши	Вспомогательная функция
 + 	Включение режима NKRO Rollover. Индикатор игрового режима мигнет дважды в качестве подтверждения.
 + 	Включение режима 6KRO Rollover. Индикатор игрового режима мигнет дважды в качестве подтверждения.

### Сброс к заводским настройкам клавиатуры:

При возникновении каких-либо проблем с клавиатурой вы можете вернуться к заводским настройкам. При этом вы потеряете свой индивидуальный светодиодный профиль.

Функциональные клавиши	Вспомогательная функция
 + 	Нажмите обе клавиши на 3 секунды, пока подсветка клавиатуры не начнет мигать.

# HyperX Alloy FPS Mekanik Oyun Klavyesi



Parça Numaraları		
Cherry® MX Blue	Cherry® MX Brown	Cherry® MX Red
HX-KB1BL1-NA/A3	HX-KB1BR1-RU/A5	HX-KB1RD1-RU/A5
HX-KB1BL1-LA/A4	HX-KB1BR1-DE/A2	HX-KB1RD1-DE/A2
HX-KB1BL1-RU/A5	HX-KB1BR1-LA/A4	HX-KB1RD1-LA/A4
HX-KB1BL1-NA/A1	HX-KB1BR1-NA/A1	HX-KB1RD1-NA/A1
HX-KB1BL1-DE/A2	HX-KB1BR1-NA/A2	HX-KB1RD1-NA/A2
HX-KB1BL1-NO/A2	HX-KB1BR1-NA/A3	HX-KB1RD1-NA/A3
HX-KB1BL1-UK/A2	HX-KB1BR1-NA/A4	HX-KB1RD1-NA/A4
HX-KB1BL1-NA/A4	HX-KB1BR1-NO/A2	HX-KB1RD1-NO/A2
HX-KB1BL1-NA/A2	HX-KB1BR1-UK/A2	HX-KB1RD1-UK/A2
HX-KB1BL1-FR/A2	HX-KB1BR1-FR/A2	HX-KB1RD1-FR/A2

**Paketin içindekiler:**

- HyperX Alloy FPS Mekanik Oyun Klavyesi
- Çıkarılabilir USB kablosu
- 8 Oyun tuşu kapağı
- Tuş kapağı çekme aleti
- Seyahat çantası





## Klavyeye Genel Bakış:

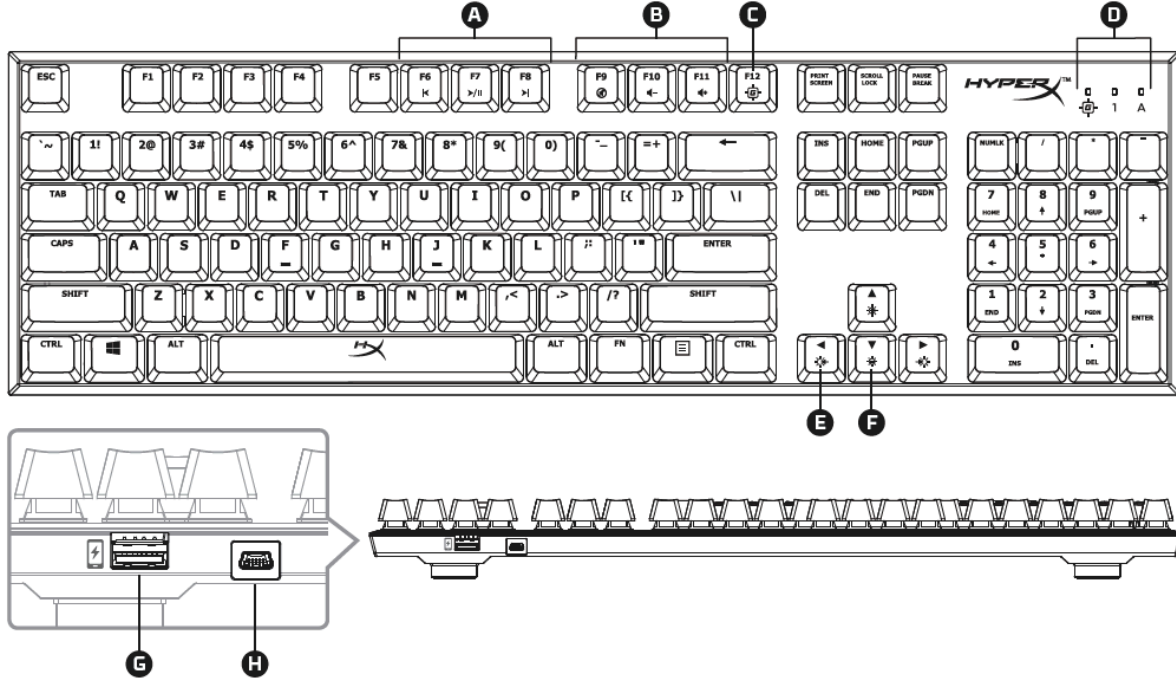

A- F6 F7 F8 = Medya tuşları.

B- F9 F10 F11 = Ses seviyesi kontrol tuşları.

C- F12 = Oyun Modu tuşu.

D- Oyun Modu / Num Lock / Caps Lock göstergeleri.

E- Sol - Sağ = LED modu kontrol tuşları.

F- Yukarı - Aşağı = LED parlaklığı kontrol tuşları.

G- Arka USB bağlantı noktası = Cep telefonu USB şarj bağlantı noktası.

H- Arka mini USB bağlantı noktası = Klavye USB kablosu bağlantı noktası.





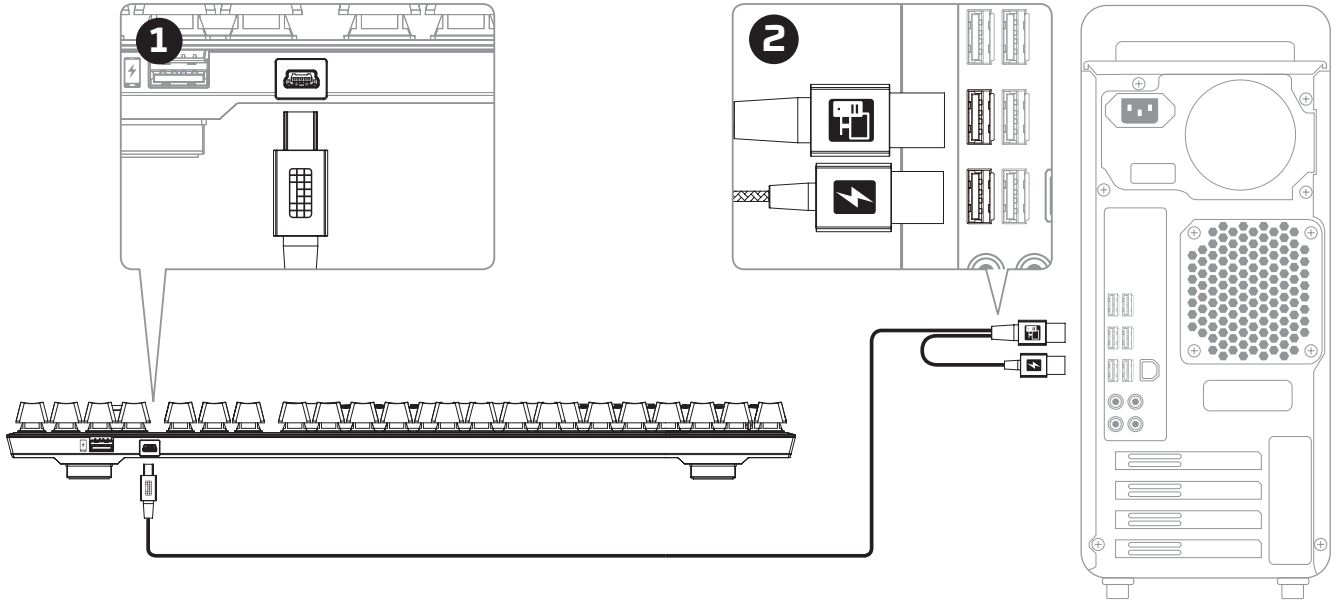















## Klavye Kurulumu:



- 1- Mini USB konnektörünü klavyeye bağlayın.
- 2- Her iki USB konnektörünü bilgisayara bağlayın.

**Fonksiyon Tuşları:**

Bir fonksiyon tuşunun ikincil özelliğini etkinleştirmek için, “FN” tuşu ile aynı anda ilgili fonksiyon tuşuna basın.

Fonksiyon Tuşları	İkincil Özellik
 +   	<p>Dinlediğiniz müzik veya izlediğiniz video için oynatma/duraklatma ►/  , geri alma ◀ veya ileri alma ► gibi işlevleri gerçekleştirin.</p>
 +   	<p>Bilgisayarınızı sessize alın , sesini azaltın  veya artırın .</p>
 + 	<p>Windows tuşunu devre dışı bırakmak ve oyunların yanlışlıkla kesintiye uğramasını önlemek için Oyun Modunu  etkinleştirin. Oyun Modu etkinleştirildiğinde, gösterge yanacaktır.</p>
 +  	<p>LED arka ışık parlaklığını artırın  veya azaltın . 5 parlaklık seviyesi bulunur: Kapalı, %25, %50, %75 ve %100.</p>

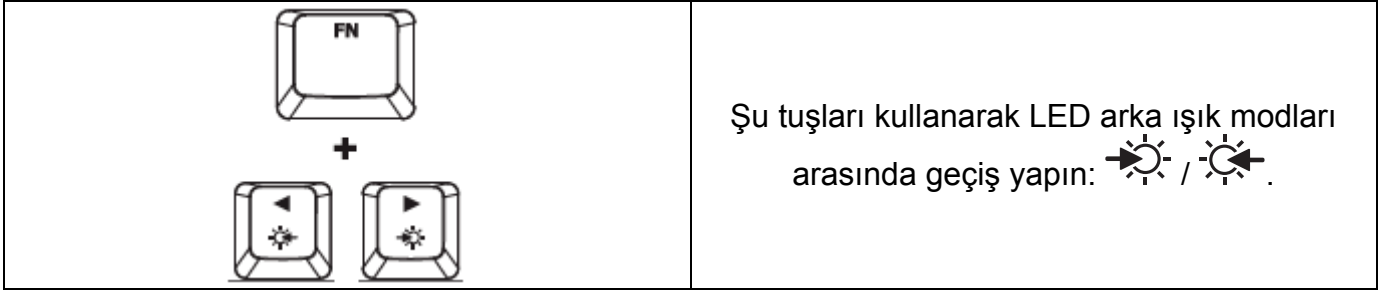



### LED arka ışık modları:



Altı farklı LED arka ışık modu bulunur: Sabit ► Nefes ► Kışkırtıcı ► Patlama ► Dalga ► Özel.

- 1- Sabit: Sabit ışık (varsayılan ayar).
- 2- Nefes: Nefes alma şeklinde yavaşça yanıp sönme.
- 3- Kışkırtıcı: Her tuş, basıldığında yanacak ve bir saniye sonra yavaşça sönecektir.
- 4- Patlama: Her bir tuşa basıldığında bir ışık efekti yayılacaktır.
- 5- Dalga: Tuşlar soldan sağa doğru dalga şeklinde yanacaktır.
- 6- Özel: Yanmasını istediğiniz tuşları seçebilirsiniz. Özelleştirmek için bu adımları izleyin:

1- Arka ışık modunu özel olarak değiştirin.

2- Arka ışık sönene kadar  + Sağ ok  tuşunu basılı tutun.

3- Arka ışığının yanmasını istediğiniz tuş veya tuşlara basın.

4- İşlem tamamlandıktan sonra, özel arka ışık profilinizi kaydetmek için tekrar  + Sağ ok  tuşuna basın.

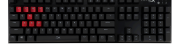
**6KRO ve NKRO aynı anda basılan tuşları doğru algılama modları:**

Aynı anda basılan tuşları doğru algılama, bastığınız her tuşun doğru olarak kaydedilmesine olanak sağlayan bir özelliktir.

6KRO varsayılan olarak etkinleştirilmiştir. Bu, aynı anda 6 tuşa ve 4 değiştirici tuşa (Windows, Alt, Ctrl, Shift) kadar basılabilmesine ve bunların doğru şekilde kaydedilebilmesine olanak sağlar.

NKRO moduna geçilerek klavyedeki her bir tuşun aynı anda doğru şekilde kaydedilmesi sağlanır.

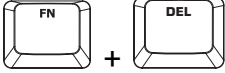
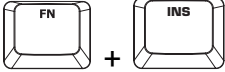
Fonksiyon Tuşları	İkincil Özellik
	NKRO aynı anda basılan tuşları doğru algılama modunu etkinleştirir. Doğrulamak için Oyun Modu göstergesi iki defa yanıp sönecektir.
	6KRO aynı anda basılan tuşları doğru algılama modunu etkinleştirir. Doğrulamak için Oyun Modu göstergesi iki defa yanıp sönecektir.

**Klavye fabrika ayarlarına sıfırlama:**

Klavye ile ilgili bir sorun yaşıyorsanız, fabrika ayarlarına sıfırlama işlemi gerçekleştirebilirsiniz. Bu işlem, özel LED profilinizin silinmesine neden olur.

Fonksiyon Tuşları	İkincil Özellik
	Klavye arka ışığı yanıp sönene kadar, her iki tuşa 3 saniye basın.





# HyperX Alloy FPS メカニカルゲーミング キーボード



製品番号		
Cherry® MX ブルー	Cherry® MX ブラウン	Cherry® MX レッド
HX-KB1BL1-NA/A3	HX-KB1BR1-RU/A5	HX-KB1RD1-RU/A5
HX-KB1BL1-LA/A4	HX-KB1BR1-DE/A2	HX-KB1RD1-DE/A2
HX-KB1BL1-RU/A5	HX-KB1BR1-LA/A4	HX-KB1RD1-LA/A4
HX-KB1BL1-NA/A1	HX-KB1BR1-NA/A1	HX-KB1RD1-NA/A1
HX-KB1BL1-DE/A2	HX-KB1BR1-NA/A2	HX-KB1RD1-NA/A2
HX-KB1BL1-NO/A2	HX-KB1BR1-NA/A3	HX-KB1RD1-NA/A3
HX-KB1BL1-UK/A2	HX-KB1BR1-NA/A4	HX-KB1RD1-NA/A4
HX-KB1BL1-NA/A4	HX-KB1BR1-NO/A2	HX-KB1RD1-NO/A2
HX-KB1BL1-NA/A2	HX-KB1BR1-UK/A2	HX-KB1RD1-UK/A2



HX-KB1BL1-FR/A2

HX-KB1BR1-FR/A2

HX-KB1RD1-FR/A2

## 製品内容:

- HyperX Alloy FPS メカニカルゲーミングキーボード
- 取り外し可能な USB ケーブル
- ゲーミングキートップ x 8
- キートップ引き抜き工具
- トラベルポーチ





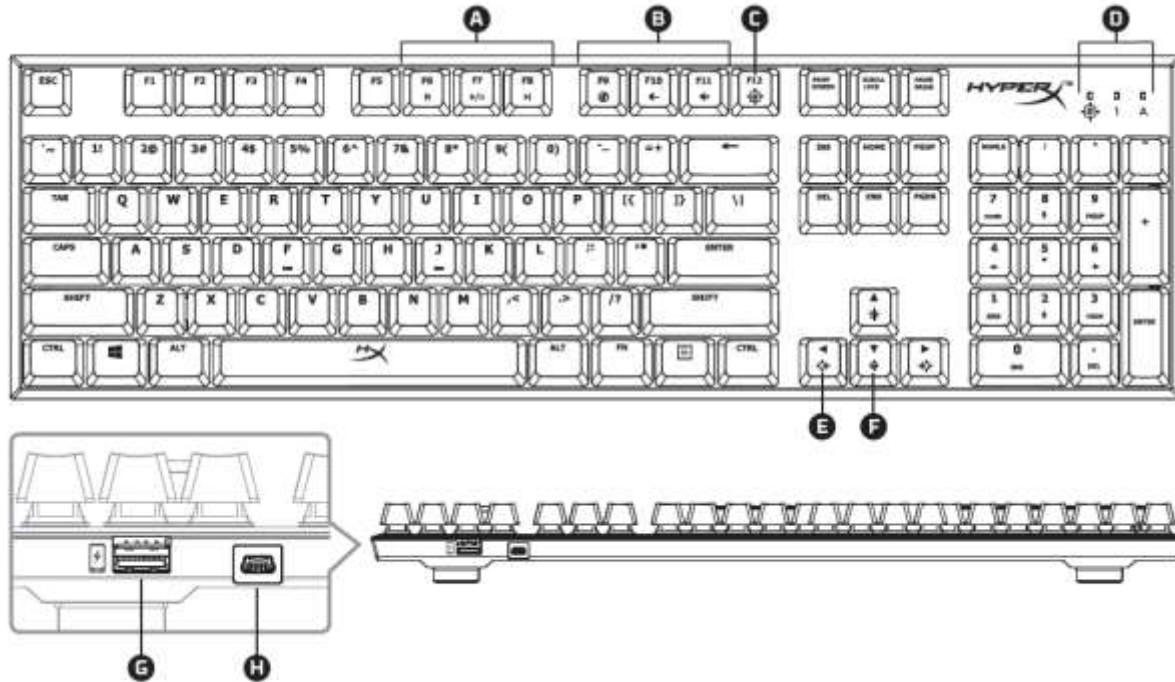

キーボードの概要:

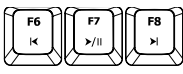

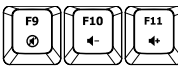
A- F6 F7 F8 = メディアキー。 

B- F9 F10 F11 = 音量コントロールキー。 

C- F12 = ゲームモードキー。 

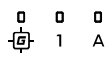
D- Game Mode / Num Lock / Caps Lock のインジケータ。 

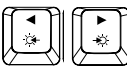
E- Left と Right = LED モードコントロールキー。 

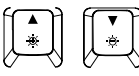
F- Up と Down = LED 明度コントロールキー。 

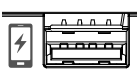
G- 背面の USB ポート = 携帯電話用 USB 充電ポート。 

H- 背面のミニ USB ポート = キーボード USB ケーブルポート。 

キーボードの取り付け:

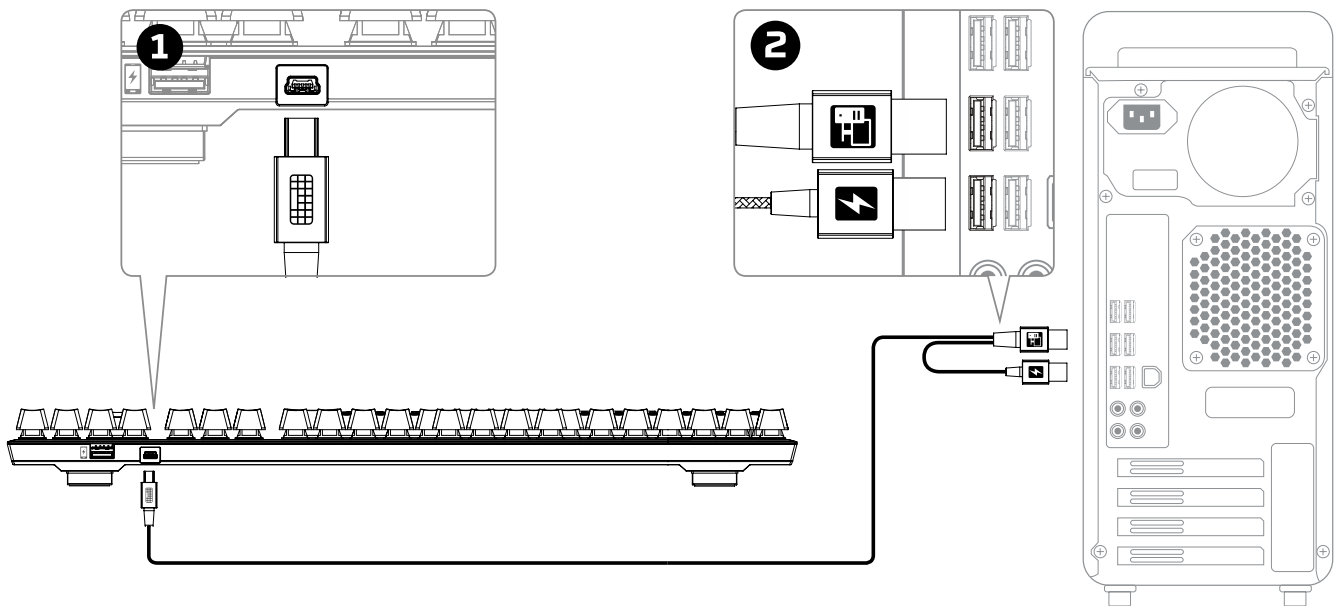

- 1- ミニ USB コネクタをキーボードに接続します。
- 2- 2つの USB コネクタをコンピューターに接続します。





ファンクションキー:

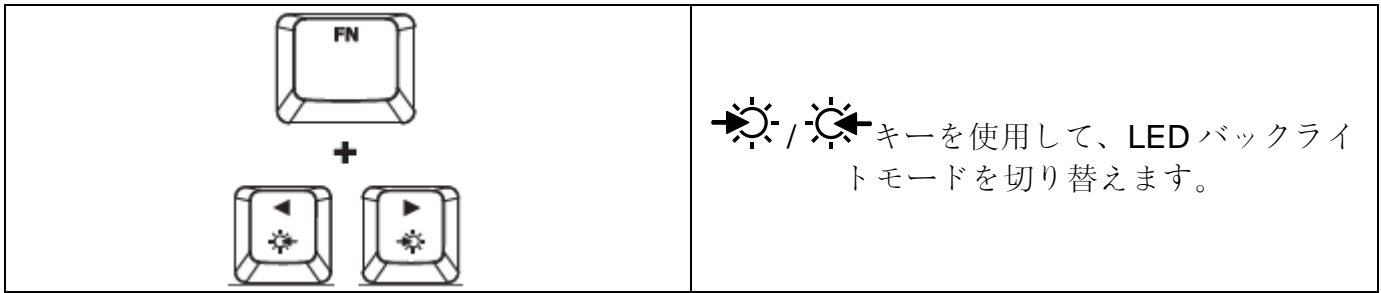

「FN」キーとファンクションキーを同時に押すと、セカンダリ機能が有効になります。

ファンクションキー	セカンダリ機能
	<p>音楽または動画を、再生/停止▶/  、逆にスキップ◀、または前にスキップ▶ します。</p>
	<p>コンピューターのオーディオをミュート🔇にするか、音量を上げ🔊+下げ🔊-します。</p>
	<p>ゲームモード🎮を有効にします。Windowsキーを無効にし、ゲームが誤って中断されないようにします。ゲームモードが有効な間は、インジケータが点灯します。</p>
	<p>LED バックライトの明るさを上げ🔆+下げ🔆-します。明るさのレベルは、オフ、25%、50%、75%、100%の5つがあります。</p>



 /  キーを使用して、LED バックライトモードを切り替えます。

### LED バックライトモード:

LED バックライトモードには、ソリッド ▶ フリージング ▶ トリガー ▶ エクスプロージョン ▶ ウェーブ ▶ カスタムの 6 つがあります。



① ソリッド:常時点灯(デフォルト設定)。



② ブリージング:呼吸するようにゆっくりと点滅します。



③ トリガー:押されたキーが光り、1 秒後にゆっくりと消えます。



④ エクスプロージョン:押されたキーを中心にして、点灯キーが放射状に広がります。





⑤ ウェーブ:波のように、左から右にキーが光ります。



⑥ カスタム:光るキーを選ぶことができます。カスタマイズの手順は、次のとおりです。

- 1- バックライトモードをカスタムに切り替えます。

- 2-  + Right  を、バックライトがオフになるまで押し続けます。

- 3- バックライトをオンにしたいキー(複数可)を押します。

- 4- 終了したら、もう一度  + Right  を押して、カスタムバックプロファイルを保存します。







### 6 キーロールオーバーモードと N キーロールオーバーモード:

キーロールオーバーとは、その数字が示す範囲内で打鍵が正しく認識される機能です。



デフォルトでは **6KRO** が有効になっています。このモードでは、最大で **6** キーと **4** つの修飾キー (Windows、Alt、Ctrl、Shift) を同時に認識できます。

**NKRO** モードに切り替えると、キーボードのすべてのキーを同時に押してもすべて正しく認識されません。

ファンクションキー	セカンダリ機能
 + 	<b>N</b> キーロールオーバーモードが有効になります。ゲームモードインジケータが <b>2</b> 回点滅し、確認できます。
 + 	<b>6</b> キーロールオーバーモードが有効になります。ゲームモードインジケータが <b>2</b> 回点滅し、確認できます。

### キーボードを工場出荷状態にリセットする:

キーボードに問題が生じた場合、工場出荷状態に戻すことができます。これにより、カスタム **LED** プロファイルは失われます。

ファンクションキー	セカンダリ機能
 + 	キーボードのバックライトが点滅するまで <b>2</b> つのキーを <b>3</b> 秒以上押し続けます。



# HyperX Alloy FPS 기계식 게임용 키보드



부품 번호		
Cherry® MX Blue	Cherry® MX 브라운	Cherry® MX 레드
HX-KB1BL1-NA/A3	HX-KB1BR1-RU/A5	HX-KB1RD1-RU/A5
HX-KB1BL1-LA/A4	HX-KB1BR1-DE/A2	HX-KB1RD1-DE/A2
HX-KB1BL1-RU/A5	HX-KB1BR1-LA/A4	HX-KB1RD1-LA/A4
HX-KB1BL1-NA/A1	HX-KB1BR1-NA/A1	HX-KB1RD1-NA/A1
HX-KB1BL1-DE/A2	HX-KB1BR1-NA/A2	HX-KB1RD1-NA/A2
HX-KB1BL1-NO/A2	HX-KB1BR1-NA/A3	HX-KB1RD1-NA/A3
HX-KB1BL1-UK/A2	HX-KB1BR1-NA/A4	HX-KB1RD1-NA/A4
HX-KB1BL1-NA/A4	HX-KB1BR1-NO/A2	HX-KB1RD1-NO/A2
HX-KB1BL1-NA/A2	HX-KB1BR1-UK/A2	HX-KB1RD1-UK/A2
HX-KB1BL1-FR/A2	HX-KB1BR1-FR/A2	HX-KB1RD1-FR/A2



구성품:



- HyperX Alloy FPS 기계식 게임용 키보드
- 분리형 USB 케이블
- 게임용 키 캡(8 개)
- 키 캡 풀러
- 여행용 파우치





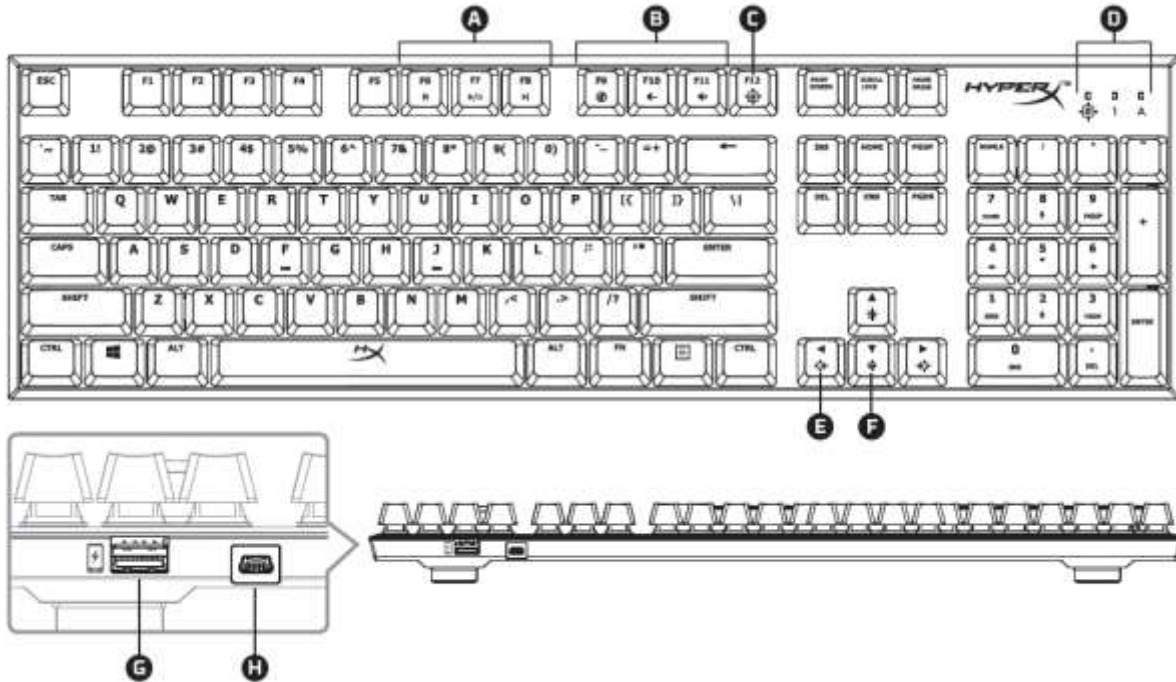



## 키보드 개요:



A- F6 F7 F8 = 미디어 키.   

B- F9 F10 F11 = 소리 조절 키.   

C- F12 = 게임 모드 키. 

D- 게임 모드 / Num Lock / Caps Lock 표시기.   

E- 왼쪽 및 오른쪽 = LED 모드 제어 키.  

F- 위 및 아래 = LED 밝기 제어 키.  

G- 후면 USB 포트 = 휴대폰 USB 충전 포트.  

H- 후면 미니 USB 포트 = 키보드 USB 케이블 포트. 

키보드 설치:

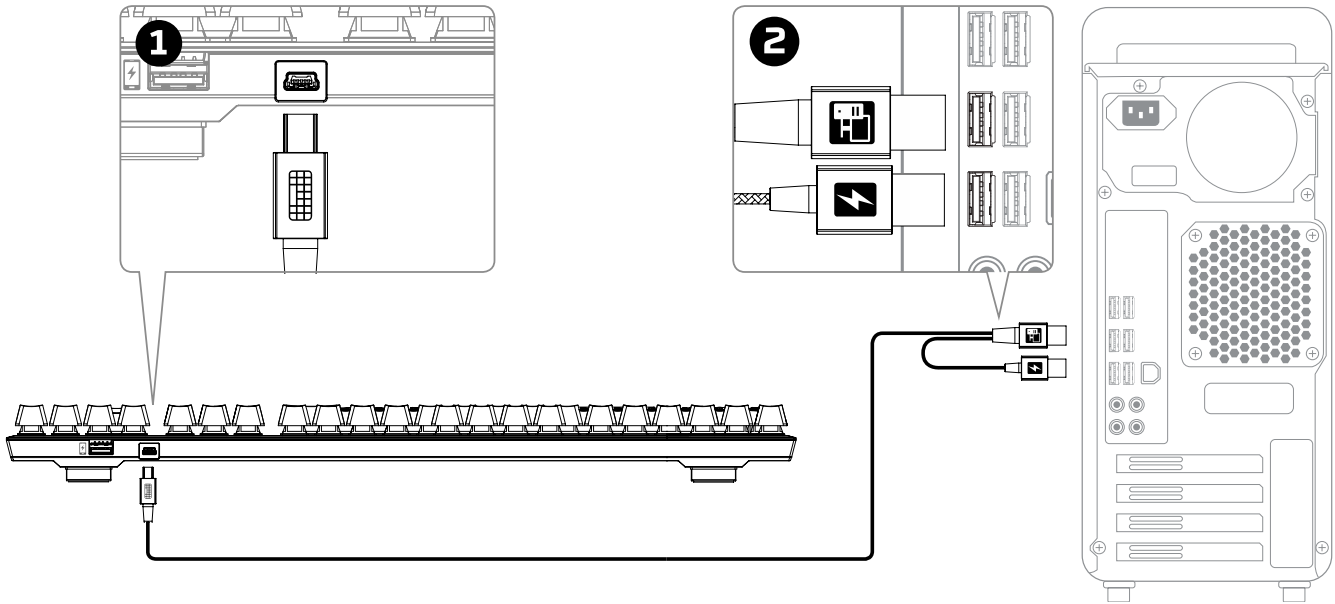



- 1- 미니 USB 커넥터를 키보드에 연결합니다.
- 2- 컴퓨터에 USB 커넥터들을 모두 연결합니다.



기능 키:

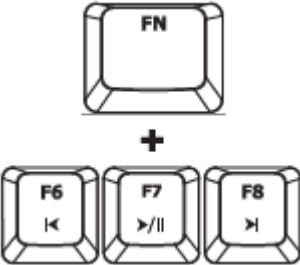
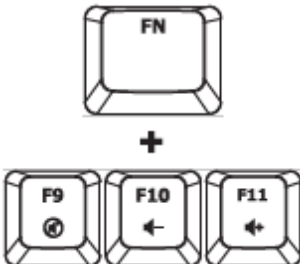

제 2 기능을 활성화하려면 동시에 "FN"과 기능 키를 누르십시오.

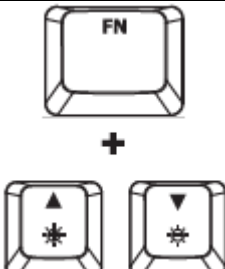
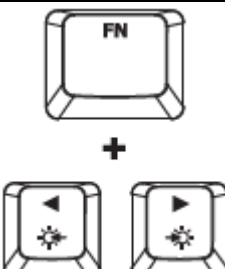
기능 키	제 2 기능
	<p>음악이나 비디오를 재생/일시 정지 ▶/  , 뒤로 건너뛰기 ◀ 또는 앞으로 건너뛰기 ▶ 하십시오.</p>
	<p>컴퓨터 오디오 볼륨을 음소거 🔇, 감소 ◀ 또는 증가 ▶+ 시키십시오.</p>
	<p>게임 모드 🎮를 활성화해 Windows 키를 비활성화하고 게임의 우발적 중단을 방지하십시오. 게임 모드가 활성화된 경우 표시기에 조명이 들어옵니다.</p>
	<p>LED 백라이트 밝기를 높이거나 ☀ 낮추십시오 ☀. 다음과 같은 5개 수준의 밝기가 있습니다. 끄기, 25%, 50%, 75%, 및 100%.</p>
	<p>다음 키 🌞 / 🌞◀로 LED 백라이트 모드를 변경하십시오.</p>



## LED 백라이트 모드:

6 개의 LED 백라이트 모드가 있습니다. 단색 ▶ 브레싱 ▶ 트리거 ▶ 폭발 ▶ 웨이브 ▶ 사용자 지정.

① 단색: 일정하게 빛남(기본 설정).

② 브레싱: 숨쉬는 것처럼 느리게 깜박거림.



③ 트리거: 개별 키들이 누를 때 마다 빛나고 1 초 후 느리게 희미해짐.

④ 폭발: 누를 때 마다 빛 효과가 개별 키에서 발광함.



⑤ 웨이브: 키가 왼쪽에서 오른쪽으로 웨이브 모양으로 빛남.

⑥ 사용자 지정: 사용자가 빛나길 원하는 키를 선택할 수 있음. 이 단계에 따라 사용자 지정하십시오.

1- 백라이트 모드를 사용자 지정으로 전환하십시오.

2- 백라이트를 끌 때까지  + 오른쪽  을 누르십시오.

3- 키 또는 백라이트 모드를 실행할 키를 누르십시오.

4- 완료되면  + 오른쪽  를 다시 눌러 사용자 지정 백라이트 프로필을 저장하십시오.



### 6KRO 및 NKRO 롤오버 모드:

키 롤 오버는 당신이 누른 모든 키들이 정확히 입력되도록 해주는 기능입니다.

6KRO 가 기본으로 설정됩니다. 최대 6 개의 키와 4 개의 전환 키(Windows, Alt, Ctrl, Shift)들이 정확하게 입력되도록 해줍니다.

NKRO 모드로의 전환은 키보드에 있는 모든 키들이 동시에 정확히 입력되도록 합니다.

기능 키	제 2 기능
 + 	NKRO 롤 오버 모드 작동. 이를 확인시키기 위해 게임 모드의 표시 장치가 두 번 깜빡임.
 + 	6KRO 롤 오버 모드 작동. 이를 확인시키기 위해 게임 모드의 표시 장치가 두 번 깜빡임.

### 키보드 공장 기본값 재설정:

키보드에 문제가 있는 경우 공장 기본값 재설정을 실행할 수 있습니다. 이를 실행하면서 사용자 지정 LED 프로필이 손실될 수 있습니다.

기능 키	제 2 기능
 + 	키보드 백라이트가 깜박일 때까지 두 키를 3 초간 누르십시오.

# แป้นพิมพ์เล่นเกม HyperX Alloy FPS



เลขชิ้นส่วน		
Cherry® MX Blue	Cherry® MX Brown	Cherry® MX Red
HX-KB1BL1-NA/A3	HX-KB1BR1-RU/A5	HX-KB1RD1-RU/A5
HX-KB1BL1-LA/A4	HX-KB1BR1-DE/A2	HX-KB1RD1-DE/A2
HX-KB1BL1-RU/A5	HX-KB1BR1-LA/A4	HX-KB1RD1-LA/A4
HX-KB1BL1-NA/A1	HX-KB1BR1-NA/A1	HX-KB1RD1-NA/A1
HX-KB1BL1-DE/A2	HX-KB1BR1-NA/A2	HX-KB1RD1-NA/A2
HX-KB1BL1-NO/A2	HX-KB1BR1-NA/A3	HX-KB1RD1-NA/A3
HX-KB1BL1-UK/A2	HX-KB1BR1-NA/A4	HX-KB1RD1-NA/A4
HX-KB1BL1-NA/A4	HX-KB1BR1-NO/A2	HX-KB1RD1-NO/A2
HX-KB1BL1-NA/A2	HX-KB1BR1-UK/A2	HX-KB1RD1-UK/A2
HX-KB1BL1-FR/A2	HX-KB1BR1-FR/A2	HX-KB1RD1-FR/A2

สิ่งที่จัดมาให้:

- แป้นพิมพ์เล่นเกม HyperX Alloy FPS
- สาย USB แบบถอดแยกได้
- แป้นครอบปุ่มสำหรับเล่นเกม 8x
- ตัวค้ำแป้นพิมพ์
- กระเป๋าใส่เดินทาง









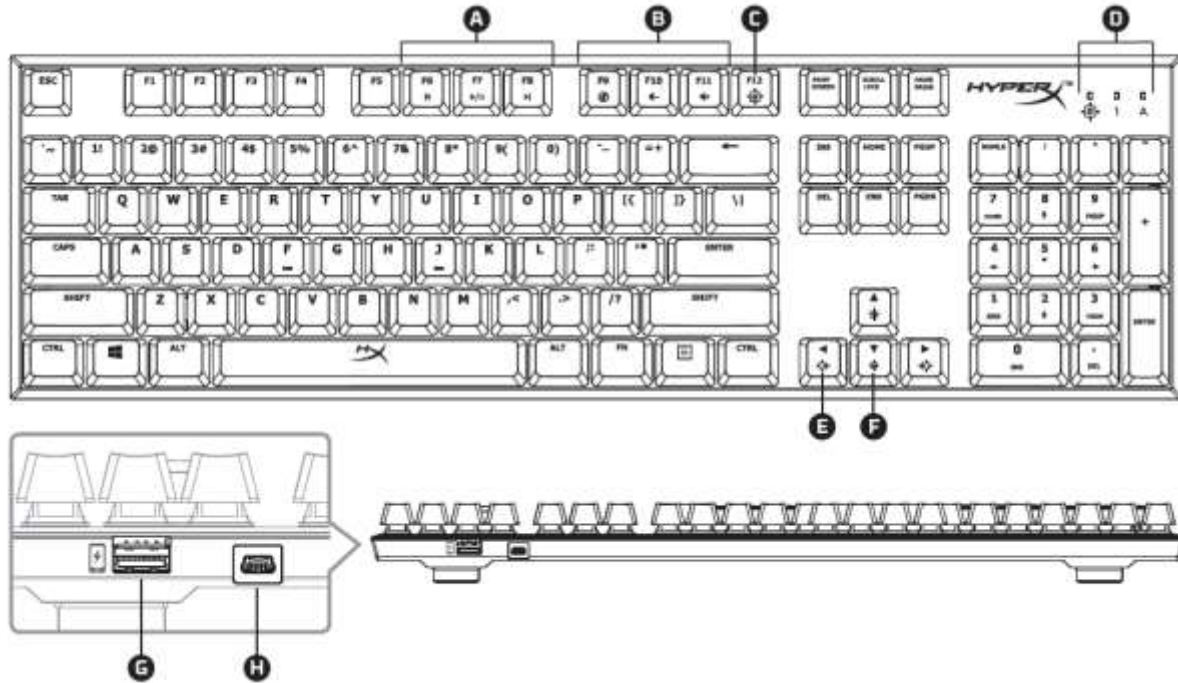



เบื้องต้นเกี่ยวกับแป้นพิมพ์:





A- F6 F7 F8 = ปุ่มมีเดีย   



B- F9 F10 F11 = ปุ่มปรับระดับเสียง   



C- F12 = ปุ่มโหมดเกม 

D- ไฟสถานะโหมดเกม / Num Lock / Caps Lock   

E- ช่ายและขวา = ปุ่มควบคุมโหมด LED  

F- ขึ้นลง = ปุ่มปรับความสว่าง LED  

G- พอร์ต mini USB ด้านหลัง = พอร์ตสาย USB แป้นพิมพ์  

H- พอร์ต mini USB ด้านหลัง = พอร์ตสาย USB แป้นพิมพ์  



การติดตั้งเป็นพิมพ์:

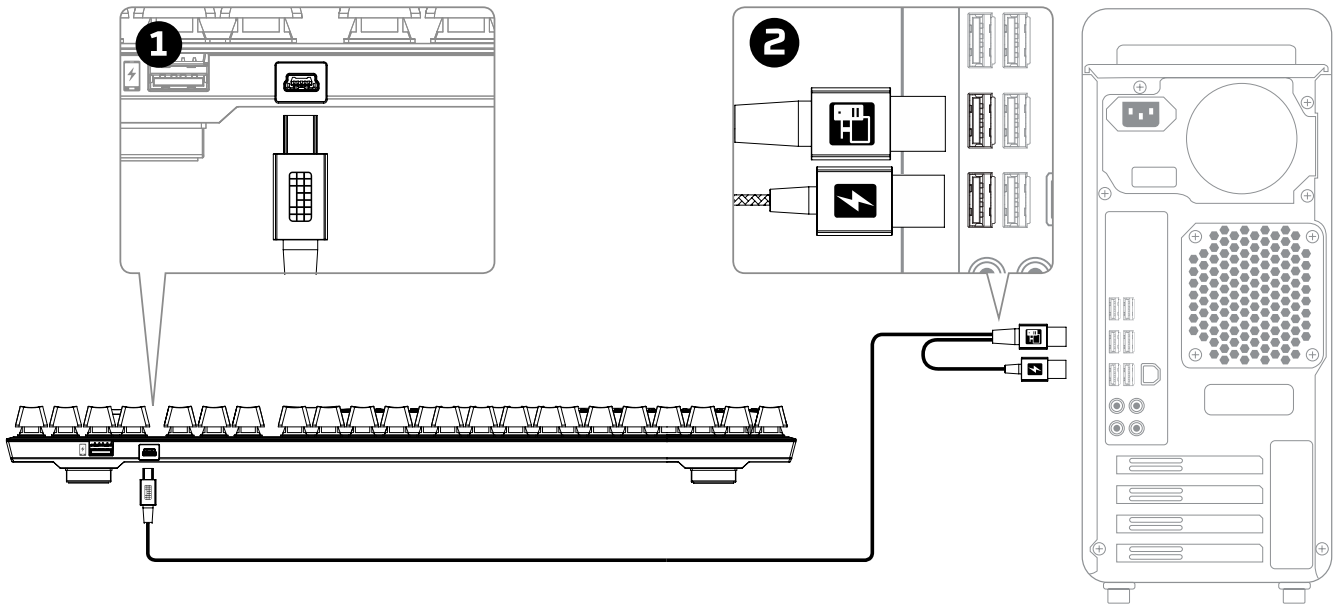

- 1- ต่อหัวต่อ Mini USB เข้ากับเป็นพิมพ์
- 2- ต่อหัวต่อ USB ทั้งสองเข้ากับคอมพิวเตอร์



ปุ่มฟังก์ชัน



กด "FN" และปุ่มฟังก์ชันพร้อม ๆ กันเพื่อเปิดใช้คุณสมบัติรองของ it

ปุ่มฟังก์ชัน	คุณสมบัติเด่นเพิ่มเติม
	<p>เปิดเล่น/หยุดชั่วคราว &gt;/   ข้ามย้อนหลัง &lt; หรือข้ามเดินหน้า &gt;  ขณะเปิดเพลงหรือวิดีโอ</p>
	<p>ปิดเสียง  ลด  หรือเพิ่ม  เสียงคอมพิวเตอร์</p>
	<p>เปิดใช้ Game Mode  เพื่อปิดใช้งานปุ่ม Windows และป้องกันการแทรกแซงระหว่างการเล่นเกมโดยไม่ได้ตั้งใจ หากเปิดใช้ Game Mode ไฟสถานะจะติดสว่าง</p>
	<p>เพิ่ม  หรือลด  ความสว่างไฟพื้นหลัง LED ปรับความสว่างได้ 5 ระดับได้แก่ ปิด, 25%, 50%, 75% และ 100%</p>

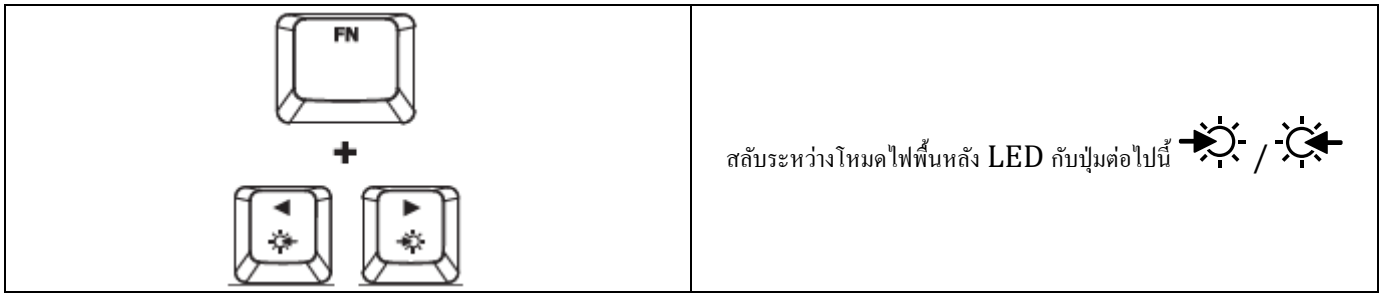

**โหมดไฟพื้นหลัง LED:**

มีโหมด LED ไฟพื้นหลังหกโหมดได้แก่ Solid ▶ Breathing ▶ Trigger ▶ Explosion ▶ Wave ▶ Custom

**Solid:** ดิคค้าง (ค่าเริ่มต้น)

**Breathing:** ไฟกะพริบเหมือนการหายใจ

**Trigger:** แต่ละปุ่มจะติดสว่างเมื่อกดปุ่ม และค่อย ๆ หายไปหลังผ่านไปหนึ่งวินาที

**Explosion:** เอฟเฟกต์แสงที่จะเปล่งแสงจากปุ่มที่กด

**Wave:** ปุ่มจะสว่างจากซ้ายไปขวาเป็นรูปคลื่น

**Custom:** คุณสามารถเลือกปุ่มที่ต้องการให้ติดสว่างได้ ทำตามขั้นตอนต่อไปนี่เพื่อกำหนดค่าเอง:

1- สลับโหมดไฟพื้นหลังเป็น Custom

2- กดค้างที่ + จนกว่าไฟพื้นหลังจะดับลง

3- กดที่ปุ่มที่คุณต้องการให้ไฟพื้นหลังเปิดทำงาน

4- หลังจากเสร็จสิ้น กด + ขวา อีกครั้งเพื่อบันทึกโปรไฟล์ไฟพื้นหลังกำหนดเองของคุณ







**โหมดโรลโอเวอร์ 6KRO และ NKRO:**

Key rollover คือคุณสมบัติที่ช่วยให้สามารถบันทึกปุ่มทุกปุ่มที่กดได้อย่างถูกต้อง

6KRO จะเปิดใช้งานเป็นค่าเริ่มต้น ซึ่งจะทำให้คุณสามารถกดปุ่มได้สูงสุด 6 ปุ่มและปุ่มตัวแปรได้ 4 ปุ่ม (Windows, Alt, Ctrl, Shift)



โดยจะมีการบันทึกจำได้ในเวลาเดียวกัน

การสลับไปใช้โหมด NKRO จะทำให้ปุ่มทั้งหมดบนแป้นพิมพ์ถูกบันทึกจำได้อย่างถูกต้องในเวลาเดียวกัน

ปุ่มฟังก์ชัน	คุณสมบัติเด่นเพิ่มเติม
 + 	เปิดใช้โหมด NKRO rollover สัญลักษณ์ Game Mode จะกะพริบสองครั้งเพื่อทำการยืนยัน
 + 	เปิดใช้โหมด 6KRO rollover สัญลักษณ์ Game Mode จะกะพริบสองครั้งเพื่อทำการยืนยัน

**รีเซ็ตแป้นพิมพ์เป็นค่าจากโรงงาน:**

หากคุณพบปัญหากับแป้นพิมพ์ คุณสามารถรีเซ็ตคืนค่าจากโรงงานได้ โพรไฟล์ LED กำหนดเองของคุณจะหายไปหลังขั้นตอนนี้

ปุ่มฟังก์ชัน	คุณสมบัติเด่นเพิ่มเติม
 + 	กดปุ่มทั้งสองเป็นเวลา 3 วินาทีจนกว่าไฟพื้นหลังแป้นพิมพ์จะติดกะพริบ

# Bàn phím chơi game cơ học HyperX Alloy FPS



Mã sản phẩm		
Cherry® MX Blue	Cherry® MX Brown	Cherry® MX Red
HX-KB1BL1-NA/A3	HX-KB1BR1-RU/A5	HX-KB1RD1-RU/A5
HX-KB1BL1-LA/A4	HX-KB1BR1-DE/A2	HX-KB1RD1-DE/A2
HX-KB1BL1-RU/A5	HX-KB1BR1-LA/A4	HX-KB1RD1-LA/A4
HX-KB1BL1-NA/A1	HX-KB1BR1-NA/A1	HX-KB1RD1-NA/A1
HX-KB1BL1-DE/A2	HX-KB1BR1-NA/A2	HX-KB1RD1-NA/A2
HX-KB1BL1-NO/A2	HX-KB1BR1-NA/A3	HX-KB1RD1-NA/A3
HX-KB1BL1-UK/A2	HX-KB1BR1-NA/A4	HX-KB1RD1-NA/A4
HX-KB1BL1-NA/A4	HX-KB1BR1-NO/A2	HX-KB1RD1-NO/A2
HX-KB1BL1-NA/A2	HX-KB1BR1-UK/A2	HX-KB1RD1-UK/A2
HX-KB1BL1-FR/A2	HX-KB1BR1-FR/A2	HX-KB1RD1-FR/A2

**Bộ sản phẩm gồm có:**

- Bàn phím chơi game cơ học HyperX Alloy FPS
- Cáp USB có thể tháo rời
- 8 chụp mũ phím game
- Dụng cụ kéo mũ phím
- Túi du lịch





## Giới thiệu chung về bàn phím:

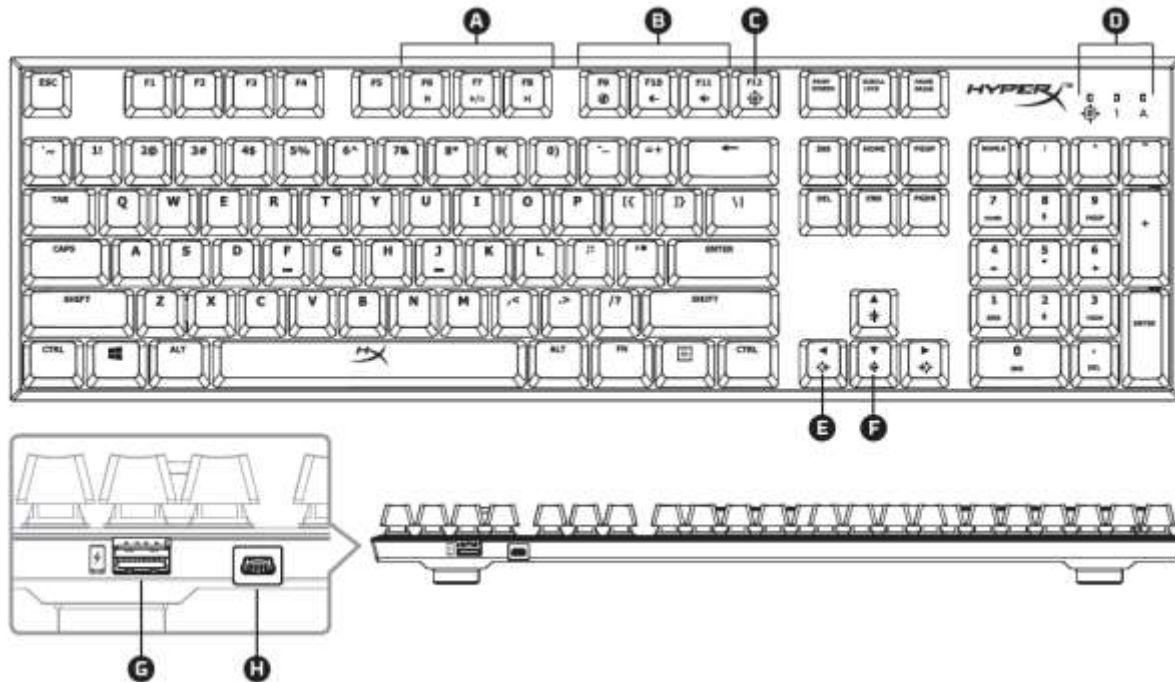

A- F6 F7 F8 = Phím media.

B- F9 F10 F11 = Phím điều chỉnh âm lượng.

C- F12 = Phím chế độ game.

D- Đèn báo Chế độ game / Khóa số /Khóa chữ hoa.

E- Trái & Phải = Phím điều khiển chế độ LED.

F- Lên & Xuống = Phím điều khiển độ sáng đèn LED.

G- Cổng USB phía sau = Cổng sạc USB cho điện thoại di động.

H- Cổng mini USB phía sau = Cổng cấp USB bàn phím.





**Cài đặt bàn phím:**

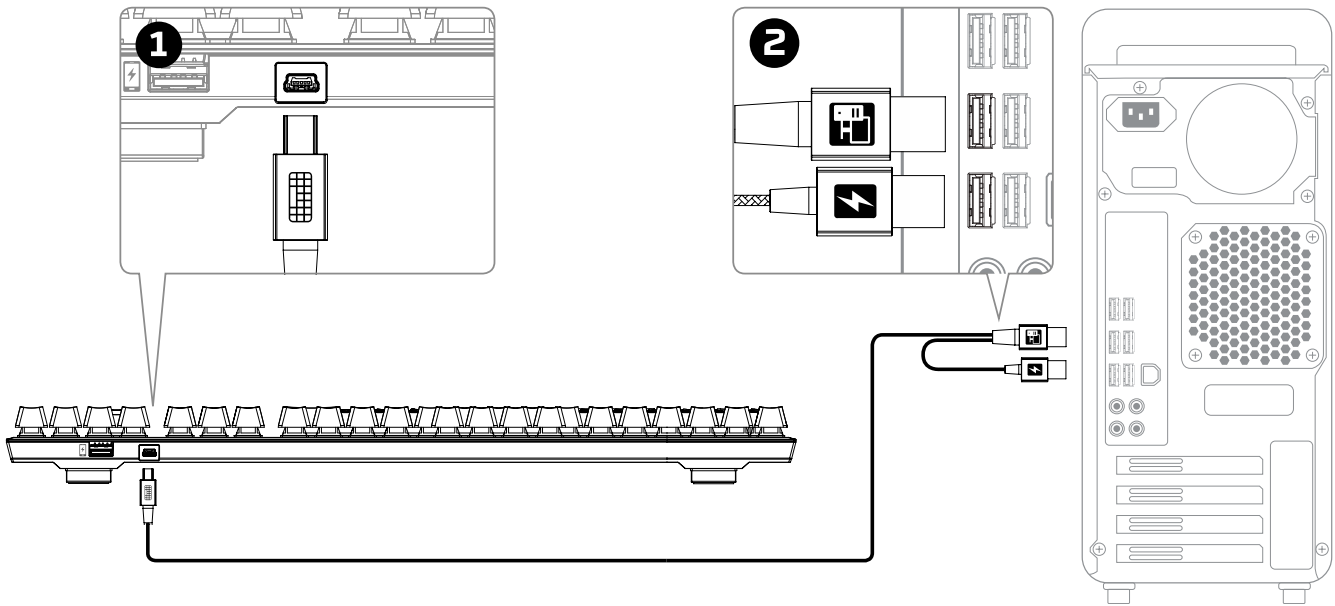

- 1- Cắm đầu Mini USB vào bàn phím.
- 2- Cắm đầu USB vào máy tính.



### Các phím chức năng:



Nhấn “FN” và một phím chức năng cùng lúc để kích hoạt tính năng phụ.

Các phím chức năng	Tính năng phụ
	<p>Mở/tạm dừng &gt;/  , tua lại ◀ hoặc tua tới ▶ bản nhạc hoặc video mà bạn muốn.</p>
	<p>Tắt tiếng 🔇, giảm 🔊- hoặc tăng 🔊+ âm thanh máy tính.</p>
	<p>Bật chế độ game 🎮 để tắt phím Windows và tránh bị vô tình can thiệp khi chơi game. Khi bật Chế độ game, đèn báo sẽ sáng.</p>
	<p>Tăng ☀️ hoặc giảm ☀️ độ sáng đèn nền LED. Có 5 cấp độ sáng: TẮT, 25%, 50%, 75% và 100%.</p>

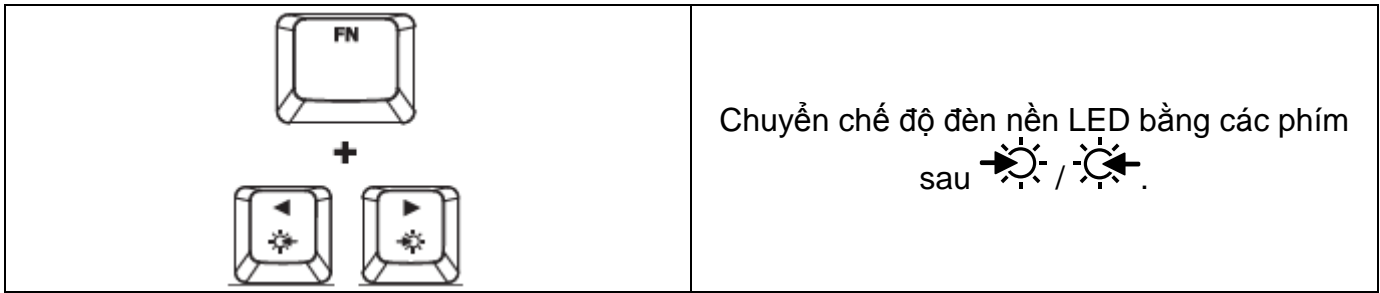

### Chế độ đèn nền LED:

Có sáu chế độ đèn nền LED: Solid (Ổn định) ► Breathing (Nhịp thở) ► Trigger (Bật sáng) ► Explosion (nổ) ► Wave (Sóng) ► Custom (Tùy chỉnh).

Solid (Ổn định): Ánh sáng ổn định (cài đặt mặc định).

Breathing (Nhịp thở): Nhấp nháy chậm theo nhịp thở.

Trigger (Bật sáng): Mỗi phím sẽ sáng lên khi nhấn rồi mờ dần sau một giây.

Explosion (NỔ): Ánh sáng sẽ phát ra từ mỗi phím khi nhấn.

Wave (Sóng): Các phím sẽ sáng theo chiều từ trái sang phải theo kiểu sóng.

Custom (Tùy chỉnh): Bạn có thể chọn các phím bạn muốn chiếu sáng. Hãy làm theo các bước sau để tùy chỉnh:

1- Chuyển chế độ đèn nền sang tùy chỉnh.

2- Giữ phím + mũi tên phải cho tới khi đèn nền tắt.

3- Nhấn các phím mà bạn muốn BẬT chế độ chiếu sáng.

4- Khi hoàn tất, nhấn lại phím + mũi tên phải để lưu cấu hình chiếu sáng tùy chỉnh.







### Chế độ gán tổ hợp phím 6KRO và NKRO:

Khả năng gán tổ hợp phím là một tính năng cho phép gán chính xác tổ hợp của mọi phím mà bạn bấm.



Chế độ 6KRO được bật là mặc định. Chế độ này cho phép gán tổ hợp 6 phím và 4 phím hỗ trợ (Windows, Alt, Ctrl, Shift).

Chuyển sang chế độ NKRO cho phép gán chính xác tổ hợp của mọi phím trên bàn phím.

Các phím chức năng	Tính năng phụ
 + 	Bật chế độ gán tổ hợp nhiều phím NKRO. Đèn báo Chế độ chơi game sẽ nhấp nháy hai lần để xác nhận.
 + 	Bật chế độ gán tổ hợp 6 phím 6KRO. Đèn báo Chế độ chơi game sẽ nhấp nháy hai lần để xác nhận.

### Đặt bàn phím về thiết lập ban đầu:

Nếu gặp sự cố với bàn phím, bạn có thể đặt nó về thiết lập ban đầu. Bạn sẽ mất cấu hình LED tùy chỉnh khi làm vậy.

Các phím chức năng	Tính năng phụ
 + 	Nhấn cả hai phím trong 3 giây cho tới khi đèn nền của bàn phím nhấp nháy.



# HyperX Alloy FPS 机械游戏键盘



产品型号		
Cherry® MX Blue	Cherry® MX Brown	Cherry® MX Red
HX-KB1BL1-NA/A3	HX-KB1BR1-RU/A5	HX-KB1RD1-RU/A5
HX-KB1BL1-LA/A4	HX-KB1BR1-DE/A2	HX-KB1RD1-DE/A2
HX-KB1BL1-RU/A5	HX-KB1BR1-LA/A4	HX-KB1RD1-LA/A4
HX-KB1BL1-NA/A1	HX-KB1BR1-NA/A1	HX-KB1RD1-NA/A1
HX-KB1BL1-DE/A2	HX-KB1BR1-NA/A2	HX-KB1RD1-NA/A2
HX-KB1BL1-NO/A2	HX-KB1BR1-NA/A3	HX-KB1RD1-NA/A3
HX-KB1BL1-UK/A2	HX-KB1BR1-NA/A4	HX-KB1RD1-NA/A4
HX-KB1BL1-NA/A4	HX-KB1BR1-NO/A2	HX-KB1RD1-NO/A2
HX-KB1BL1-NA/A2	HX-KB1BR1-UK/A2	HX-KB1RD1-UK/A2
HX-KB1BL1-FR/A2	HX-KB1BR1-FR/A2	HX-KB1RD1-FR/A2

包含内容：

- HyperX Alloy FPS 机械游戏键盘
- 可拆卸 USB 线缆
- 8 个游戏键帽
- 键帽工具
- 旅行袋





## 键盘概览：

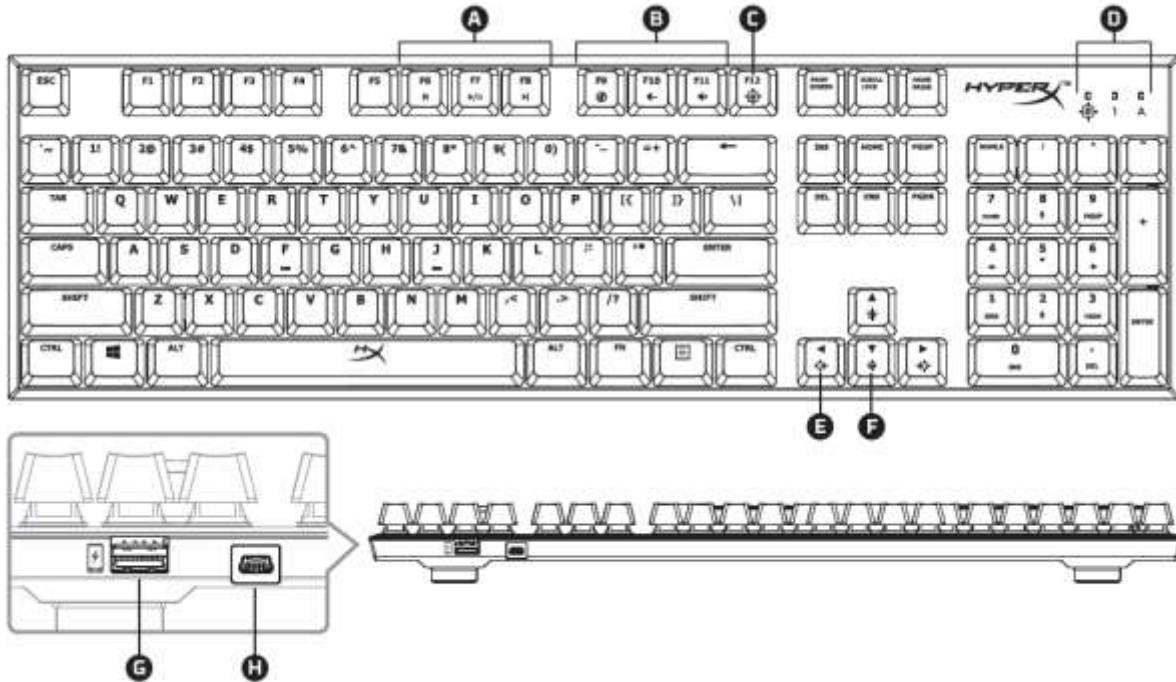

- A- F6 F7 F8 = 多媒体按键。 
- B- F9 F10 F11 = 音量控制键。 
- C- F12 = 游戏模式键。 
- D- 游戏模式/数字锁定/大写锁定标识。 
- E- 向左和向右 = LED 模式控制键。 
- F- 向上和向下 = LED 亮度控制键。 
- G- 背部 USB 端口 = 手机 USB 充电端口。 
- H- 背部迷你 USB 端口 = 键盘 USB 线缆端口。 



键盘安装：

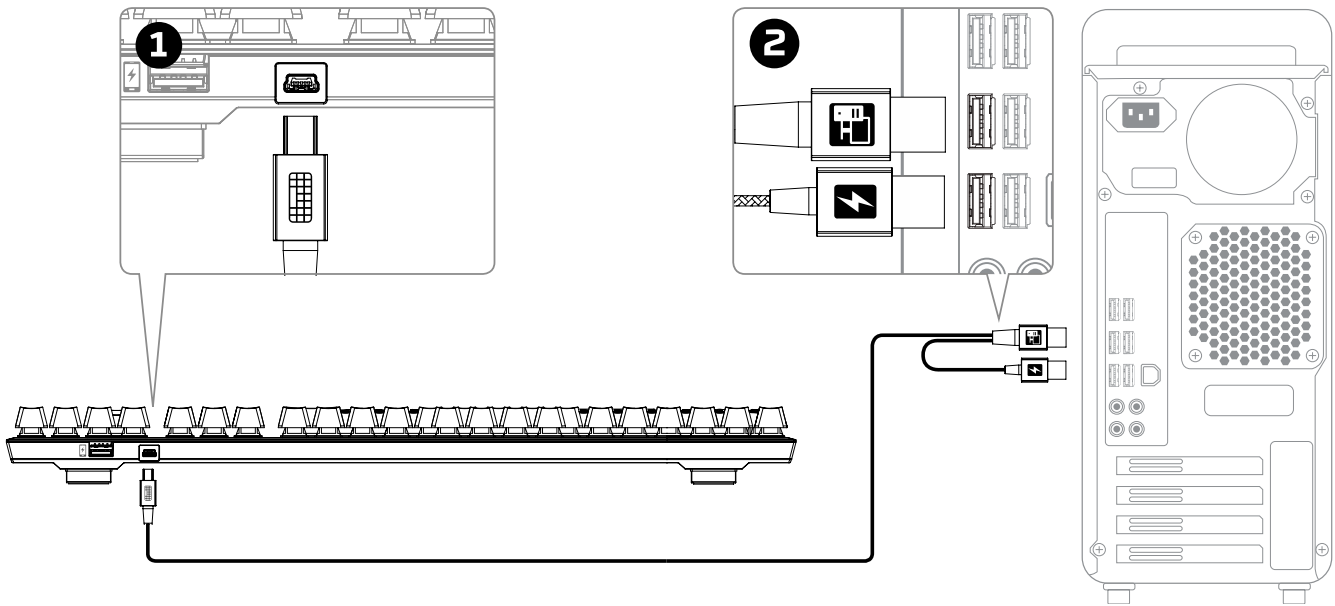

- 1- 将迷你 USB 端口连接到键盘。
- 2- 将两个 USB 端口连接到电脑。





功能键：



同时按下“FN”和功能键，即可激活其次要功能。

功能键	次要功能
	播放/暂停▶/  、向后跳过◀或向前跳过▶音乐或视频。
	静音🔇、调低◀-或调高+▶计算机音频。
	启动游戏模式🎮可禁用 Windows 键并防止意外中断游戏。启用游戏模式时，指示灯会亮起。
	调高☀️或降低☹️ LED 背光亮度。共有 5 个亮度级别：关闭、25%、50%、75% 和 100%。
	使用以下按键🔆/🔆，在 LED 背光模式之间切换。

## LED 背光模式：

共有 6 种 LED 背光模式：常亮 ▶ 呼吸 ▶ 单点亮起 ▶ 扩散 ▶ 波浪 ▶ 自定义。



常亮：持续发光（默认设置）。



呼吸：像呼吸一样缓缓闪烁。



单点亮起：按下之后，单个按键会亮起，一秒钟后慢慢消失。



扩散：按下之后，单个按键发出的灯光效果。



波浪：按键以波浪形方式从左到右依次亮起。





自定义：可以选择您希望亮起的按键。按照如下步骤进行自定义设置：

1- 将背光模式切换到自定义。

2- 按住  + 右边的  直到背光灯熄灭。

3- 按住一个或多个您希望亮起背光的按键。

4- 完成后，再次按住  + 右边的 ，即可保存自定义的背光灯配置文件。



### 6KRO 和 NKRO 无冲突模式：

按键无冲突功能可正确注册您按下的每个键。

默认情况下，启用 6KRO 模式。这样可同时最多注册 6 个键和 4 个修饰键（Windows、Alt、Ctrl、Shift）。

切换到 NKRO 模式之后，可同时正确注册键盘上的每个按键。

功能键	次要功能
	启用 NKRO 无冲突模式。游戏模式指示灯会闪烁两次以进行确认。
	启用 6KRO 无冲突模式。游戏模式指示灯会闪烁两次以进行确认。

### 键盘恢复出厂设置：

如果遇到任何键盘问题，可以执行恢复出厂设置。这样会失去自定义的 LED 配置文件。

功能键	次要功能
	按下两个键保持 3 秒钟，直到键盘背光开始闪烁。



# HyperX Alloy FPS 機械式電競鍵盤



產品型號		
Cherry® MX 青軸款	Cherry® MX 茶軸款	Cherry® MX 紅軸款
HX-KB1BL1-NA/A3	HX-KB1BR1-RU/A5	HX-KB1RD1-RU/A5
HX-KB1BL1-LA/A4	HX-KB1BR1-DE/A2	HX-KB1RD1-DE/A2
HX-KB1BL1-RU/A5	HX-KB1BR1-LA/A4	HX-KB1RD1-LA/A4
HX-KB1BL1-NA/A1	HX-KB1BR1-NA/A1	HX-KB1RD1-NA/A1
HX-KB1BL1-DE/A2	HX-KB1BR1-NA/A2	HX-KB1RD1-NA/A2
HX-KB1BL1-NO/A2	HX-KB1BR1-NA/A3	HX-KB1RD1-NA/A3
HX-KB1BL1-UK/A2	HX-KB1BR1-NA/A4	HX-KB1RD1-NA/A4
HX-KB1BL1-NA/A4	HX-KB1BR1-NO/A2	HX-KB1RD1-NO/A2
HX-KB1BL1-NA/A2	HX-KB1BR1-UK/A2	HX-KB1RD1-UK/A2
HX-KB1BL1-FR/A2	HX-KB1BR1-FR/A2	HX-KB1RD1-FR/A2

內容物：

- HyperX Alloy FPS 機械式電競鍵盤
- 可拆式 USB 電源線
- 8 顆遊戲鍵帽
- 鍵帽拔除器
- 攜帶用收納袋





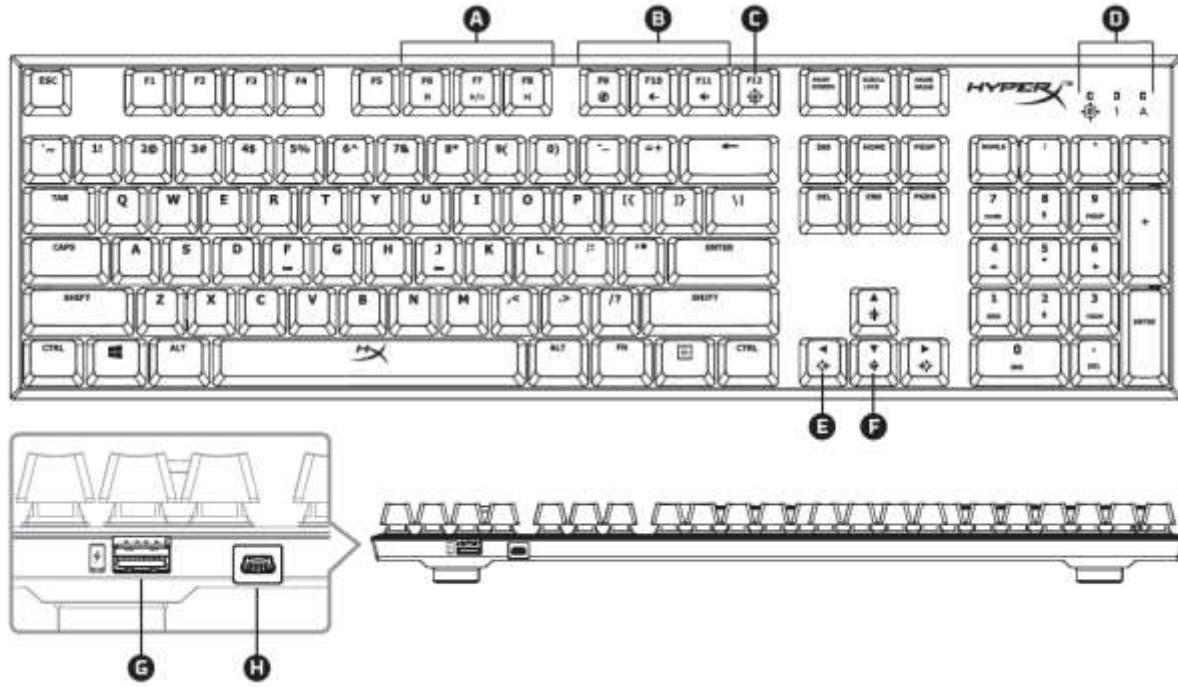

鍵盤總覽：



A- F6 F7 F8 = 媒體鍵。 

B- F9 F10 F11 = 音量控制鍵。 

C- F12 = 遊戲模式鍵。 

D- 遊戲模式 / 數字鎖定 / 大小寫鎖定指示燈。 

E- 左 & 右 = LED 模式控制鍵。 

F- 上 & 下 = LED 亮度控制鍵。 

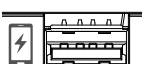
G- 後方 USB 連接埠 = 行動電話 USB 充電埠。 

H- 後方 mini USB 連接埠 = 鍵盤 USB 電源線連接埠。 



鍵盤安裝：

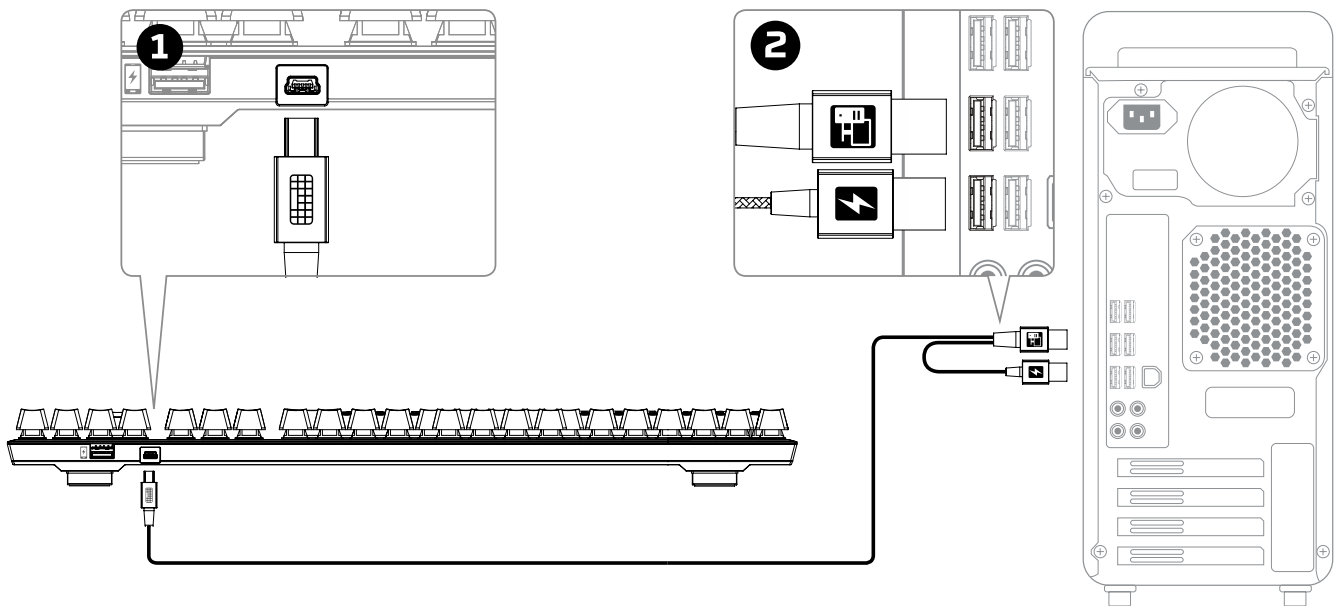

- 1- 將 mini USB 接頭連接至鍵盤。
- 2- 連接兩組 USB 至電腦。



功能鍵：



同時按下“FN”鍵以及一個功能鍵，即可啟用該按鍵的輔助功能。

功能鍵	輔助功能
	<p>播放/暫停▶/  、倒轉◀或快轉▶音樂或影片。</p>
	<p>靜音🔇、降低◀-或調高◀+電腦音量。</p>
	<p>啟用遊戲模式🎮來停用 Windows 鍵，以避免遊戲中發生誤觸干擾。當遊戲模式啟用時，指示燈亮起。</p>
	<p>調高☀️或降低☀️ LED 背光亮度。本產品共有 5 個亮度等級：關閉、25%、50%、75% 和 100%。</p>
	<p>使用以下按鍵切換 LED 背光模式☀️ / ☀️。</p>



## LED 背光模式：

本產品有 6 種 LED 背光模式：恆亮 ▶ 呼吸 ▶ 單點 ▶ 爆破 ▶ 波浪 ▶ 自訂。



恆亮：持續發光（預設）。



呼吸：模仿呼吸節奏，緩慢地閃爍。



單點：單獨按鍵將會於按下時亮起，並於一秒鐘後慢慢熄滅。



爆破：按下單獨按鍵時，將會產生放射性燈光效果。



波浪：按鍵將會由左至右以波浪形式亮起。



自訂：你可以選擇你希望亮起的按鍵。依照以下步驟來設定自訂模式：

- 1- 將背光模式切換至自訂：

- 2- 長按  + 右鍵  直到背光關閉。

- 3- 按下你希望啟用背光的按鍵。

- 4- 結束時，按下  + 右鍵  來儲存你的背光設定。



### 6KRO 和 NKRO 按鍵不衝突模式：

按鍵不衝突功能能夠讓你每次按下按鍵時都正確執行。

預設啟用狀態為 6KRO。能夠讓最多 6 個按鍵和 4 個輔助按鍵（Windows、Alt、Ctrl、Shift）同時執行。

變換為 NKRO 模式可以讓鍵盤上的每一顆按鍵同時按下並正確執行。

功能鍵	輔助功能
	啟用 NKRO 全鍵不衝突模式。遊戲模式指示燈將會閃爍兩次，表示確認。
	啟用 6KRO 按鍵不衝突模式。遊戲模式指示燈將會閃爍兩次，表示確認。

### 鍵盤原廠重設：

如果你的鍵盤有任何問題，你可以將鍵盤還原為原廠設定。請注意，這麼做會讓你失去自訂的 LED 設定。

功能鍵	輔助功能
	同時按下兩個按鍵 3 秒，直到鍵盤背光閃爍。